

Emergy-based environmental accounting toward a sustainable Mongolia

LI Haitao¹, BROWN Mark^{1,2}

1. Key Laboratory of Land Surface Pattern and Simulation, Institute of Geographic Sciences and Natural Resources Research, CAS, Beijing 100101, China;
2. Center for Environmental Policy, Engineering School of Sustainable Infrastructure and Environment, University of Florida, Gainesville, FL 32611, USA

Abstract: An emergy-based environmental accounting of Mongolia is presented based on the data from 1995 to 2012. By calculating natural and economic inputs and a series of emergy indicators, this paper discusses Mongolia's resource use structure, economic situation, trade status and societal sustainability. The results show that the total emergy use for Mongolia changed from 2.83×10^{22} sej in 1995 to 4.96×10^{22} sej in 2012, representing a 75% increase over the 18 years of this study, yet its emergy per capita remains one of the lowest in the world (1.74×10^{16} sej/capita). The emergy money ratio (EMR) of Mongolia during 1995–2012 decreased from 1.99×10^{13} sej/USD to 7.75×10^{12} sej/USD, which indicates that the power of a dollar for purchasing real wealth in Mongolia was declining, while the relatively high absolute values compared to its trading partners and even the world average EMR suggests that Mongolia is continuing a trade disadvantage. Mongolia's emergy exchange ratio is increasingly less than one to the point that in 2012 the ratio was 0.3 suggesting that the exported emergy was over 3.3 times greater than the imported emergy. The growing dependence on imports and the dramatic increase in exports suggests that Mongolia's economy is increasingly vulnerable to downturns in the world economy.

Keywords: emergy; resources; sustainability; Mongolia

1 Introduction

The country of Mongolia, lies in Central Asia, and without the benefit of a coastal location, it has a strong continental climate, the result of being dominated by a region of high atmospheric pressure throughout much of the year (Worden and Savada, 1989). The spatial distribution of its climate transitions gradually from a semi-humid region in the north and east to semi-arid, arid, and extremely arid regions in the south and west. The climate of Mongolia is extremely variable and more than any other factor, has resulted in an environment dominated by ecologically marginal areas, which are unsuited to agriculture. This, in turn, has generated a culture of nomadic pastoralism in response to the variability of the climate and mar-

Received: 2017-02-24 **Accepted:** 2017-04-07

Foundation: Chinese Academy of Sciences President's International Fellowship Initiative, No.2016VBA043(BM); China Scholarship Council and Michigan State University, No.NN-X-09-AM-55G(LH)

Author: Li Haitao, PhD, E-mail: liht@igsnr.ac.cn

ginal ecosystems that permanent cropping or livestock grazing would soon deplete. Today nearly one half of Mongolia's population still depends on livestock production, which contributes a little more than 20% of the country's GDP (Vernooy, 2011).

Due to the fragile nature of its environment, Mongolia's ecosystems are increasingly vulnerable to changes in climate and to human activity. The most important environmental issues include increasing rangeland degradation, land desertification, soil acidification and erosion, reduction in available water resources, and rapid decreases in forest resources (CIA, 2016). Farming and animal husbandry, particularly sheep and goat herding, are the traditional means of subsistence. However, emphasis on industrial and economic growth during the last two decades has greatly affected this region, and brought an increasing pressure on natural ecosystems. The ability to maintain a balance between economic growth and ecosystem stability, and thus foster long-term societal sustainability, has become a serious challenge for the people of Mongolia.

In recent years, Mongolia has increased development of its mineral resources expecting to gain significant economic and social benefits from expansion of the mining sector. With significant deposits of metals (copper, gold, silver, copper, molybdenum, tungsten, tin, nickel, zinc, and fluorspar) and energy (uranium, oil, and coal), Mongolia has increased its export income six fold in the past decade from \$1.1 billion in 2004 to \$6.1 billion in 2014. The top exports (monetary value) in 2014 as percentage of total value of exports, were copper ore (42%), coal briquettes (14%), crude petroleum (11%) and iron ore (7%), (OEC, 2016).

Mongolia is a state in transition, from a country dominated by nomadic pastoralism to an economy largely relying on the export of raw materials to international markets. The country's main exports are mined minerals, metals and fossil fuels (primarily coal) and secondarily, livestock products (especially cashmere). Mongolia depends heavily on imports of machinery, fuels, industrial and consumer goods, and food products. Current estimates suggest that the total monetary value of Mongolia's mineral wealth is on the order of \$1.3 to \$2.75 trillion (ECSP, 2017). Investment in Mongolia's mining sector has topped \$14 billion in the period 2008–2013 (Mungunzul and Chang, 2016), an amount equal to over 50% of Mongolia's GDP for those years.

With such unprecedented mineral wealth, the achievement of long-term national well-being would seem to be possible. Yet learning from other developing economies, mineral wealth alone does not guarantee a sustainable future. While the monetary flows are impressive and the future looks bright for continued investment and even larger export earnings, understanding the real wealth of Mongolia and the difference between value in exchange (monetary value) and value in use (emergy value) may provide policy makers with a better way of directing resources in beneficial ways.

The objectives of this paper are three fold, to evaluate: (1) the temporal changes of Mongolia's resources use, imports and exports from 1995 to 2012; (2) economic efficiency and trade status of Mongolia; (3) the sustainability of Mongolia system, and make suggestions for its sustainable future on the basis of the emergy synthesis of the Mongolia's environmental and economic systems. In order to achieve these objectives, the main flows of energy, materials and money passing through the boundaries of the region are quantified and standardized; the emergy flow of renewable resources, non-renewable resources, imports and exports are calculated; a series of emergy indices of Mongolia, such as emergy dollar ratio

(EDR), energy-based resources productivity (ERP), energy exchange ratio (EER), environmental load ratio (ELR) and energy yield ratio (EYR), are evaluated.

2 Materials and methods

2.1 Study area

Mongolia (87°44'–119°56'E, 41°35'–52°09'N, Figure 1) is a landlocked country situated in an arid and semi-arid zone in Northeast Asia. It is bordered by Russia to the north and the People's Republic of China to the south, east and west. In total, Mongolia covers an area of 1.564 million km² (CIA, 2016).

The geography of Mongolia is varied with the Gobi Desert to the south and with cold and mountainous regions to the north and west, about 1130.523 thousand km² or 73.9% of the territory is marginal agricultural land (of which 97.8% is meadows and pastures in 2012), 9.2% is forest land, 0.4% is surface water resources and about 0.3% is in urban areas (MSY, 1995–2012). Located in Central Asia, Mongolia is an upland country with 85% of its land above 1000 m asl. Much of Mongolia's grassland is located between 1000 m and 2500 m asl (MSY, 1995–2012). Annual precipitation of Mongolia from the year of 2000 to 2004 was 165.9 mm (Batjargal, 1997). The average summer temperature in Ulaanbaatar, the capital of Mongolia, is between +11°C and +25°C, while average winter temperature is between –30°C and –15°C (WWO, 2016).



Figure 1 Map of Mongolia

With a population of 2.85 million persons (2012), and a population density of 1.82 people per square kilometer, Mongolia is one of the most sparsely populated countries in the world. In earlier times the majority of the population practiced pastoralism, while in 2012, about 62.6% of the total population or 1.78 million persons lived in urban areas (MSY, 1995–2012).

Currently, Mongolia's economy is centered on agriculture and mining (coal, copper, molybdenum, fluorspar, tin, tungsten, and gold). The gross domestic product of Mongolia was US\$ 6.4 billion in 2012, 21.1% of which was produced by the agriculture sector (MSY, 2009). In 2012, livestock comprised three-quarters of economic value-added agriculture (meat, hide, wool, cashmere, dairy products), while crops made up the rest (wheat and vegetables for domestic consumption). Industry accounted for around 59.8% of GDP, which included mining and quarrying (the share of mining and quarrying industries in the total industrial sales reached 65.9%), processed wool, cashmere, leather, and food (mostly meat and dairy products), and construction materials (MSY, 1995–2012). In recent years, Mongolia is increasingly dependent on mined minerals and metals as well as fossil fuels for the bulk of its export earnings (MSY, 1995–2012).

2.2 Data sources

Data sources for this research are from published yearbooks and internet data compilations, such as Mongolian Statistical Yearbook (MSY, 1995–2012), the CIA Fact Book (CIA, 2016), Food and Agricultural Organization (FAO Stat, 2016), United States Energy Information Agency (EIA, 2016), United Nations Environmental Program (UNEP, 2016) and several others. The majority of the data on Mongolian local resources production and consumption, imports and exports was sourced from Mongolian Statistical Yearbook (MSY, 1995–2012).

2.3 Emergy analysis

An emergy analysis of Mongolia was conducted to characterize the flows of energy, resources and services driving the system. In emergy analysis flows of energy, material, or service in a system are transformed into common units of solar emergy (the units of which are solar emjoules, abbreviated sej) by multiplying units of energy or mass by a unit emergy value (UEV). UEVs are defined as the available energy of one form (usually solar) that is required to produce a unit of another form (Odum, 1996). If the units produced are in joules of available energy, then the UEV is called *transformity*. If the units produced are expressed in mass, the UEV is called *specific emergy*. The units of each are as follows: transformity = sej/J and specific emergy = sej/g. A third type of UEV is emergy per unit of currency, such as dollars, in which case the units are sej/\$.

2.3.1 Emergy baseline

Crucial to the method of emergy accounting are the main driving emergy flows of the geobiosphere to which all other flows are referenced. They form what is referred to as the geobiosphere emergy baseline (GEB) for the construction of tables of Unit Emergy Values (UEVs) to be used in emergy evaluations. The three main sources of available energy that form the GEB (Odum, 1996) are solar radiation received by Earth, tidal momentum created by the earth-sun-moon system, and geothermal energy from deep within the earth.

Over the past several decades different baselines have been proposed and used by emergy researchers, the result of incremental increases is useful in understanding of geobiosphere processes and gaining more refined data. Most recently a baseline of $12.0 \text{ E}24 \text{ sej y}^{-1}$ (Brown *et al.*, 2016) has been proposed by several researchers working in tandem, but using different approaches. The emergy baseline used in this analysis was $12.0 \text{ E}24 \text{ sej y}^{-1}$ (Brown *et al.*, 2016). UEVs obtained from other sources (see below) were computed using other

previous baselines. Conversion of UEVs produced with different baselines was done using the ratio of the old baseline to the new baseline as follows:

Baseline of 9.44 E24 sej y⁻¹ was multiplied by 12.0/9.44,

Baseline of 15.83 E24 sej y⁻¹ was multiplied by 12.0/15.83

Baseline of 15.2 E24 sej y⁻¹ was multiplied by 12.0/15.2

2.3.2 Unit emergy values (UEVs)

In practice UEVs are computed from real processes that have been in operation for sufficient time that they are likely to be operating at close to optimal performance. Ideally UEVs are computed for each analysis, however time and resource constraints make this ideal difficult to obtain. Instead, most emergy analyses (especially those as complex as an analysis of a country with many input flows), rely on UEVs computed by others. Odum (1996), along with others (Brown and Ulgiati, 1999; Tilley, 1999; Odum *et al.*, 2000; Bastianoni *et al.*, 2005), have computed UEVs for a variety of products and services. Two databases, the National Environmental Accounting Database (NEAD, 2016) and the Emergy Data Base (Tilley *et al.*, 2016) provide comprehensive lists of UEVs previously computed by others. UEVs used in this study were obtained from these and other sources.

In addition to the above sources, we have used UEV's for mineral resources from a new, unpublished study (De Vilbiss and Brown, 2016) that was performed for the USEPA. This study developed UEVs for 102 minerals that are used in industry, construction, and agriculture. The method used to compute the mineral UEVs and the resulting values depart significantly from those previously published. Additionally, the UEV for rainfall and all subsequent global flows of water (i.e., river discharges), taken from this same publication, differ in method of computation and the ultimate values from UEVs used in the past. As a result of these differences in computations and final UEV values for minerals, rainfall, and river discharges, the results of this national analysis are not easily compared to national analysis that have been performed in the past.

The reliability of UEVs obtained from other sources was evaluated by contrasting values from several sources where possible. If different sources differed significantly we choose to take an average, or settled on a UEV that represented the majority of values from the literature. Of course, uncertainties are always present and are transferred from these previous studies to the present study. Finally, as is well known, only the largest of the flows can significantly affect the outcome, so through our investigation, we focused our attention on those flows that represented the largest contributions to total emergy.

2.3.3 Environmental accounting

The biophysical basis for the Mongolia's economy was derived by accounting for all the flows of energy and materials that are consumed (both imported and obtained within Mongolia) and exported. Accounting tables were constructed for each year of the analysis (1995–2012) and data in energy and mass units were obtained from published sources. All data were converted to emergy using appropriate UEVs from the literature.

The renewable sources of energy to Mongolia were identified as solar radiation, the deep heat of the earth, precipitation, and wind. Since there is potential to double count emergy when accounting for renewable energy, special accounting procedures were adopted (de-

veloped by Brown and Ulgiati, 2016b). To avoid double-counting of renewable energy sources the sum of solar radiation and deep heat was compared to the largest of the other renewable inputs (precipitation) and the larger of those two values was taken as the renewable input (Figure 2).

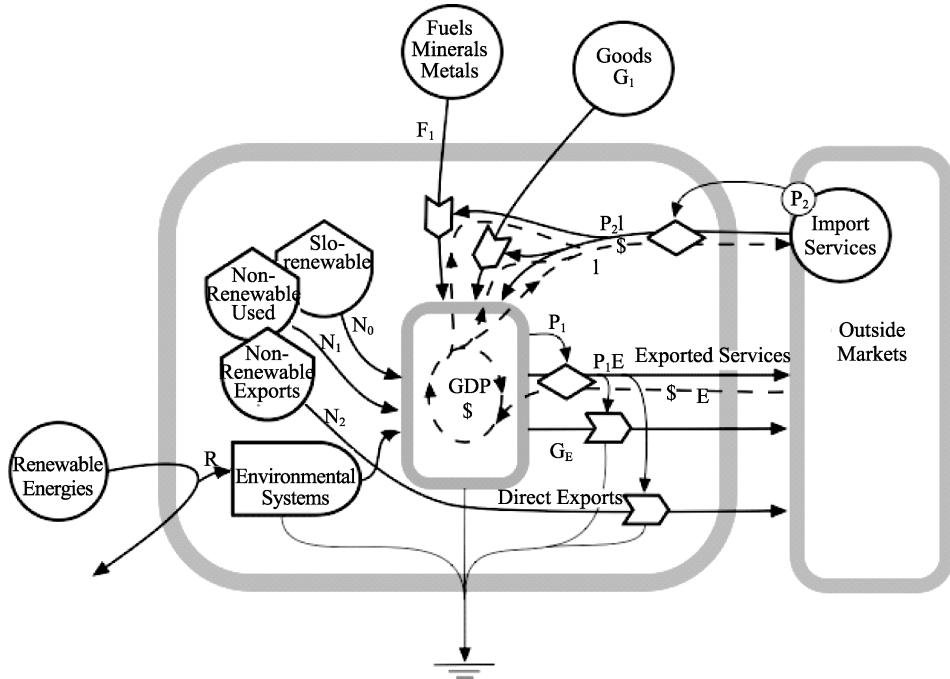

Figure 2 Aggregated national diagram from which energy indices and ratios are computed

2.3.4 Energy intensity indices

Intensity in the sciences refers to the quantity of something expressed in relation to some other quantity. For instance, in physics, intensity is power transferred per unit area. In economics, energy intensity is calculated as units of energy input per unit of GDP. In this study we compute three different energy intensities: 1) empower per capita (total annual energy use divided by population, 2) aerial empower intensity (total annual energy use per unit area), and 3) energy money ratio (EMR: total annual energy use per dollar of annual GDP)

2.3.5 Energy performance indices

Several performance indicators were computed to compare year to year performance of the Mongolia's economy and to compare Mongolia with other countries. Referring to Figure 2, the most important of these indices are as follows:

Environmental Loading Ratio – $(N_0 + N_1 + F_1 + G_1 + P_2I) / R$. The ELR is the ratio of the non-renewable energy used by the economy to the renewable energy. Lower ELRs are better.

Export to Import Ratio – $(N_2 + G_E + P_1E) / (F_1 + G_1 + P_2I)$. The export to import ratio is the ratio of the energy of exports to the energy of imports. Values greater than 1.0 indicate economies that export more energy than they import.

Energy Exchange Ratio – $(F_1 + G_1 + P_2I) / (G_E + N_2 + (I * EMR))$. The energy exchange ratio (EER), a measure of trade efficiency, is the ratio of energy received by the buyer, to the

energy given, in a trade or sales transaction. Ratios greater than 1 indicate positive trade advantage, while ratios less than one indicate negative trade advantage.

3 Results and discussion

3.1 Systems diagram

Given in Figure 3 is a systems diagram of modern Mongolia showing the main driving energies, imports, exports and internal processes. The diagram is used as a means of inventorying the main characteristics of the biophysical economy and also showing the main flows of money received for exports and spent for imports. The internal circulation of money is not included in the diagram, but each flow of energy or resource within the economy would have an accompanying flow of money in the opposite direction.

The main renewable energy inputs are solar energy, winds, and precipitation. Also included as a renewable source is the geologic input, here evaluated as geothermal exergy. Non-renewable inputs purchased from outside include fuels and electricity, goods and machines, food, and services. To the left in the diagram are the ecological systems including forests, steppes, desert grasslands, and the Gobi Desert. The most important sectors of Mongolia's economy are the pastoralists (nomads) and their cattle in the center of the diagram, mining in the lower right, and industry, center left, not necessarily in the order of importance. Nowadays urban areas have become increasingly important as the economy has shifted away for pastoralism toward industrialization.

Mongolia's main exports, shown flowing from the left to international markets, include products from industrial output, agricultural commodities from the nomads and agriculture, and coal, metals and minerals from the mining sector. These exports are shown with a counter flow of money as income from their sale.

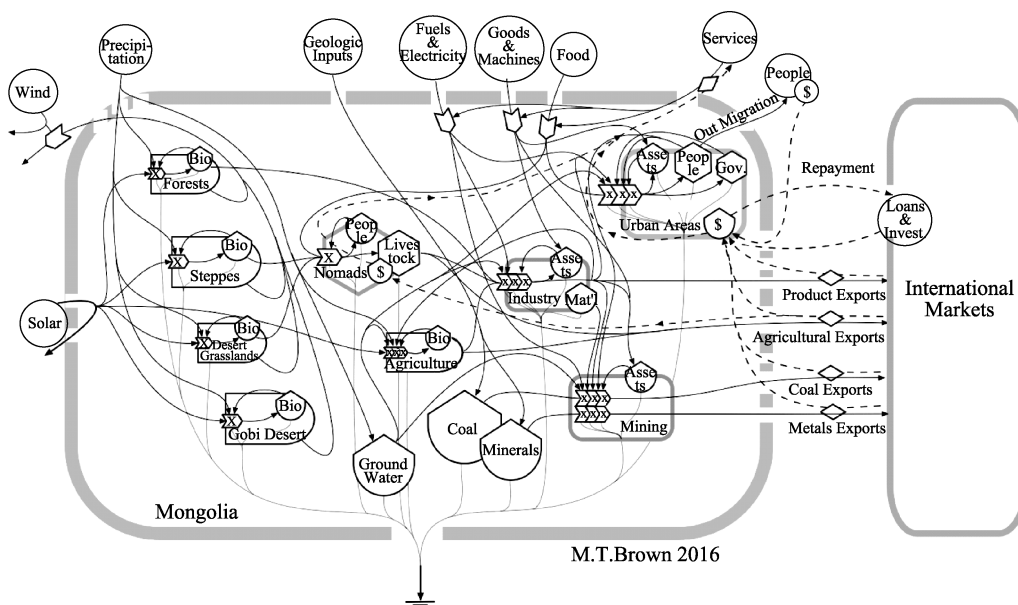

Figure 3 Systems diagram of Mongolia showing the driving energies, exchanges of resources and money and the main sectors of the economy

3.2 Emergy analysis

Table 1 is an emergy accounting of Mongolia for the year 2008 as an example of the tables constructed for each year of the study period. The table explains the main categories of energy and material flows that were aggregated to make the summary statistics for each of the 18 years of this study. Notes to Table 1 that provide a summary of calculation procedures and sources for all data are given in Appendix A.

Table 1 Emergy evaluation of Mongolia (2008)

Note	Item	Raw units		UEV (sej/unit)	Solar emergy (E20 sej)
Primary renewable sources					
1	Solar radiation	6.10E+21	J	1	61.0
2	Earth Cycle, heat flow	1.87E+17	J	4900	9.2
Sum of primary sources					70.2
Secondary and tertiary renewable sources					
3	Wind, kinetic energy	9.93E+18	J	800	79.4
4	Precipitation (Chem. Pot.)	1.13E+18	J	7000	79.3
5	Runoff geopotential	1.88E+17	J	12800	24.0
6	River, geopotential	0.00E+00	J	12800	0.0
7	River, chemical potential	0.00E+00	J	21300	0.0
Sum of items 4 and 5					103.3
Total renewable (largest of primary or 2nd and 3rd sources)					103.3
Indigenous renewable production:					
8	Hydroelectricity	0.00E+00	J	2.54E+05	0.0
9	Agriculture production	1.05E+16	J	2.54E+05	26.8
10	Livestock production	6.24E+14	J	2.54E+06	15.8
11	Fisheries production	7.74E+11	J	2.54E+06	0.0
Nonrenewable sources from within system:					
12	Fuelwood production	5.24E+15	J	1.87E+04	1.0
13	Forest extraction	1.53E+16	J	1.87E+04	2.9
14	Natural gas	0.00E+00	J	1.40E+05	0.0
15	Oil	1.10E+16	J	1.40E+05	15.3
16	Coal	1.72E+17	J	5.21E+04	89.5
17	Minerals	6.10E+10	g	5.26E+08	0.3
18	Metals	1.84E+12	g	7.60E+07	1.4
19	Topsoil losses	9.62E+16	J	2.01E+04	19.3
20	Water (gd. water extraction)	5.58E+15	J	4.80E+04	2.7
Imports:					
21	Fuels	4.10E+16	J	1.32E+05	54.1
22	Metals	7.43E+10	g	6.73E+07	0.1
23	Minerals	1.70E+13	g	4.75E+07	8.1
24	Electricity	8.68E+14	J	2.54E+05	2.2
25	Food & agriculture products	5.77E+15	J	4.28E+05	24.7
26	Livestock, meat, fish	8.93E+13	J	2.54E+06	2.3
27	Plastics & rubber	4.92E+14	J	1.32E+05	0.6

(To be continued on the next page)

(Continued)

Note	Item	Raw units		UEV(sej/unit)	Solar energy (E20 sej)
28	Chemicals	7.53E+10	g	1.12E+10	8.5
29	Finished products	9.14E+11	g	3.66E+09	33.5
30	Mach.& trans equip.	7.52E+10	g	1.90E+10	14.3
31	Service in imports	3.24E+09	\$	1.27E+12	41.1
Exports:					
32	Food & agriculture products	2.47E+14	J	2.54E+05	0.6
33	Livestock, meat, fish	3.66E+14	J	2.54E+06	9.3
34	Finished products	1.19E+11	g	3.79E+09	4.5
35	Fuels	1.27E+17	J	5.60E+04	71.3
36	Metals	7.82E+11	g	2.73E+08	2.1
37	Minerals	4.78E+10	g	1.00E+09	0.5
38	Chemicals	4.12E+09	g	1.12E+10	0.5
39	Electricity	3.64E+13	J	2.54E+05	0.1
40	Mach. & trans equip.	1.47E+09	g	1.44E+10	0.2
41	Plastics & rubber	2.40E+11	J	1.32E+05	0.0
42	Service in exports	2.53E+09	\$	8.52E+12	215.8

Footnotes to Table 1 are given in Appendix A

Table 2 summarizes the data in Table 1 by providing summaries of inputs and outputs according to larger classifications of renewable, nonrenewable, goods, services etc. The letters in the first column are keyed to the diagram in Figure 2.

Table 2 Summary of energy and monetary flows for Mongolia (2008)

Variable	Item	Solar energy ^a (E20 sej/y)	Dollars
R	Renewable sources (rain, tide, earth cycle)	103.3	
N	Nonrenewable resources from within country	132.3	
N₀	Dispersed rural source	22.0	
N₁	Concentrated use	110.4	
N₂	Exported without use	73.9	
F₁	Imported fuels, minerals & electricity	64.4	
G₁	Imported goods	83.8	
I	Money paid for imports (\$US)		3.24E+09
P₂I	Energy of services in imported goods & fuels	41.1	
E	Money received for exports (\$US)		2.53E+09
P₁E	Services in exports	215.8	
G_E	Exported energy in goods	15.1	
F_E	Exported fuels, minerals & electricity	74.0	
P₂	World energy/\$ ratio, used in imports	1.27E+12	
P₁	Country energy/\$US ratio	8.52E+12	

a. Data are summarized from Table 1

The aggregated system diagram of Mongolia in 2008 provides an overview of the energy and money flows across system boundaries and the Gross Domestic Product (GDP), in the central circular flow of money (Figure 4). The diagram summarizes the interaction of renewable and non-renewable resources within the system and the exchanges of energy and dollars that drive the system's economy. Sources of energy from outside that cross the system boundary include: the renewable resources (R) (free environmental inputs), imported fuels and minerals (F), goods (G) and the services embodied in these imports (P_2I) (purchased from economy outside the system). Sources of energy derived from storages within the country include: (N_0) (dispersed rural resources that are used faster than they are renewed such as soils or forest biomass harvested at unsustainable rates) and (N_1) non-renewable resources (fossil fuels, metals and minerals). Exports from the system include: non-renewable resources (N_2) that are exported without upgrading in the economy, finished products (B), and services and labor (P_1E) embodied in B.

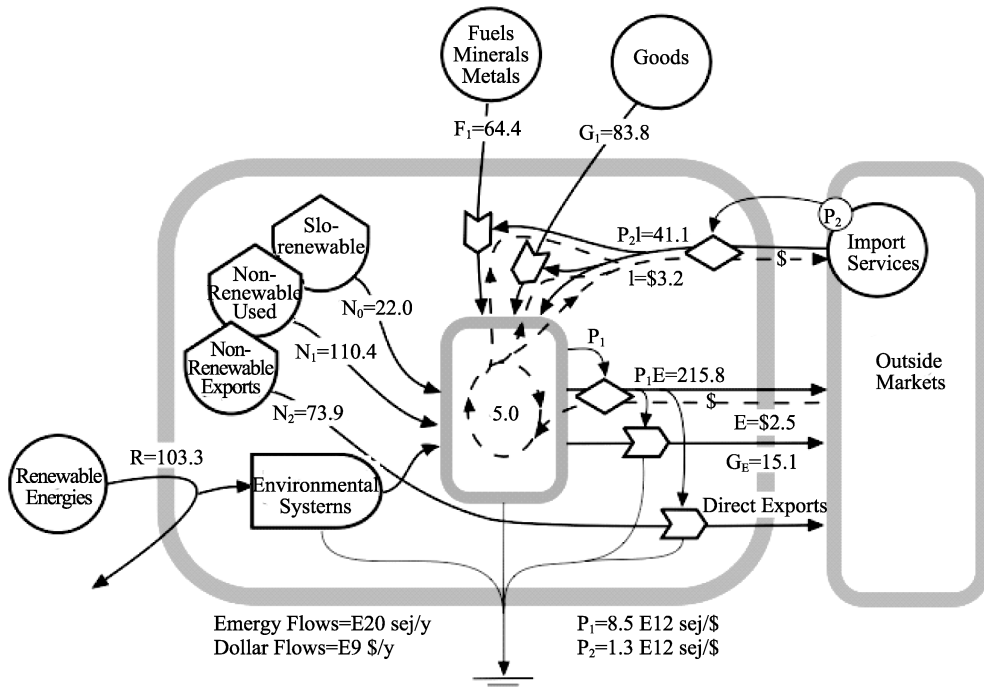

Figure 4 Aggregated diagram summarizing the quantities of energy and money flowing into and out of the Mongolia's economy (Table 2 lists each of the pathways and their definition)

The aggregated systems diagram in Figure 4 was used to construct a number of indices of energy and monetary flows that are given in Table 3. Under the column labeled "expression" the equation of the flows used to compute the index is given.

In 2008 the renewable energy inflows equaled 103.3×10^{20} sej (note that to avoid double counting the renewable inflows were computed as the sum of energy of the chemical potential of precipitation utilized by plants (transpired) and the geopotential of the remaining precipitation that runs-off the landscape). Slowly renewable and non-renewable resources that are from within Mongolia totaled 132.4×10^{20} sej, while imports of fuels minerals and finished goods were 148.2×10^{20} sej. Overall, the total energy driving the economy of Mongolia in 2008 (the sum of the renewables [R], slow renewables [N_0] and non-renewables [N_1])

Table 3 Indices using energy for overview of Mongolia (2008)

Item	Name of index	Expression ^a	Quantity
1	Renewable energy flow	R	1.03E+22
2	Nonrenewable resources from within the country	N	1.32E+22
3	Flow of imported energy (incl. services)	$F_1+G_1+P_2I$	1.89E+22
4	Total energy inflows (incl. services)	$R+F_1+G_1+P_2I$	2.93E+22
5	Total energy support, (U) (incl. services)	$R+N_0+N_1+F_1+G_1+P_2I$	4.25E+22
6	Total energy support, (U_{MOD}) (NOT incl. services)	$R+N_0+N_1+F_1+G_1$	3.84E+22
7	Exported energy (NOT incl. services)	$G_E + F_E$	8.91E+21
8	Exported energy (incl. services)	$G_E + F_E + P_1E$	3.05E+22
9	Percent energy from home sources	$(N_0+N_1+R)/U$	55%
10	Imports minus exports (incl. services)	$(F_1+G_1+P_2I) - (F_E+G_E+P_1E)$	-1.16E+22
11	Imports minus exports (NOT incl. services)	$(F_1+G_1) - (F_E+G_E)$	-8.91E+21
12	Balance of payments (Export\$ – Import\$)	$(E - I)$	-7.06E+08
13	Export to imports ratio (incl. services)	$(F_E+G_E+P_1E) / (F_1+G_1+P_2I)$	1.61
14	Export to imports ratio (NOT incl. services)	$(F_E+G_E) / (F_1+G_1)$	0.60
15	Percent of energy locally renewable	R/U	24.3%
16	Percent of energy purchased	$(F_1+G_1+P_2I)/U$	45%
17	Percent of energy as imported service	P_2I/U	10%
18	Percent of energy that is free	$(R+N_0+N_1)/U$	55%
19	Ratio of concentrated to rural	$(F_1+G_1+P_2I+N_1)/(R+N_0)$	2.39
22	Environmental loading ratio (ELR)	$(N_0+N_1+F_1+G_1+P_2I) / R$	3.11
23	Energy yield ratio (EYR)	$(R+N_0+N_1+F_1) / (P_2I +G_1)$	2.40
24	Energy sustainability index	EYR/ELR	0.77
25	Ratio of energy to GDP (EMR)	$P_1=U/GDP$	8.52E+12
26	Ratio of energy to GDP (EMR, NOT including service)	$P_1=U_{MOD}/GDP$	7.69E+12
20	Energy per unit area, aerial empower Intensity	$U/(\text{area m}^2)$	2.72E+10
21	Energy per person	$U/\text{population}$	1.58E+16

a. letters refer to variable in Table 2 and Figure 2.

used from within the country, and the imports of fuels and minerals [F_1] and finished goods [G_1] equaled 383.9×10^{20} sej. If the services of the imported fuels and goods are included then the total energy driving the economy in 2008 was 425.0×10^{20} sej.

Mongolia's energy balance of payments (Table 3) was negative in 2008 as was its monetary balance of payments (-7.06×10^8 USD). Often, especially in developed countries, a negative monetary balance of payments is accompanied by a positive energy balance of payments which indicates that they are exporting finished products and importing raw resources. The fact that in 2008 both the monetary and energy balance of payments were negative suggests that Mongolia's economy is one that is highly subsidizing developed countries with which it trades. The money received for raw resources exported is always much less than their true value to the economic system that imports and uses them (Brown *et al.*, 2009; Brown and Ulgiati, 2011).

In 2008, the global average energy use per capita was 5.22×10^{16} sej/capita (NEAD, 2016), while Mongolia's energy per capita in that same year was 1.58×10^{16} sej/capita (Ta-

ble 3), suggesting that Mongolia is somewhat below world average. In that same year, China’s emergy per capita was 3.1×10^{16} sej/capita (NEAD, 2016). Aerial empower intensity of Mongolia was 2.7×10^{10} sej m^{-2} in 2008 (Table 3). Compared to the world average in 2008 (3.1×10^{12} sej m^{-2} : NEAD, 2016), Mongolia’s overall emergy intensity is well below (2 order of magnitude) the world average, highlighting the relatively small overall emergy economy of the country. Mongolia’s emergy money ratio (EMR) in 2008 was 8.5×10^{12} sej/USD compared to the world average of 2.7×10^{12} sej/USD indicates that Mongolia was at a relatively high disadvantage when trading with other nations, exporting more resource wealth than it imports, dollar for dollar.

3.3 Time series emergy accounting

An emergy accounting of each of the 16 years between 1995 and 2012 was conducted like that shown in Table 1. Appendix B provides the summary data for each year, and Appendix C provides the summary indices.

3.3.1 Emergy flows in Mongolia

Figure 5 shows total emergy input in Mongolia for the period 1995–2012. The total emergy use (U) changed from 2.83×10^{22} sej in 1995 to 4.96×10^{22} sej in 2012, resulting in a 75% increase over the 16 years. The various components of emergy use changed as well. Figure 6 shows the change in percentage of total use of the components of the emergy budget between 1995 and 2012. Renewable emergy (R) was 39% of the total in 1995 but only comprised 23% in 2012. In like manner, local non-renewable emergy ($N_0 + N_1$) decreased from 41% in 1995 to 33% in 2012. Imported emergy flows (F_1) increased slightly from 18% in 1995 to 21% in 2012. And imported goods (G_1) increased from 2% in 1995 to over 41% of total emergy budget in 2012. These data suggest not only that Mongolia’s economy was growing (75% in 16 years), but also an economy that is increasingly reliant on external sources of energy, materials and information.

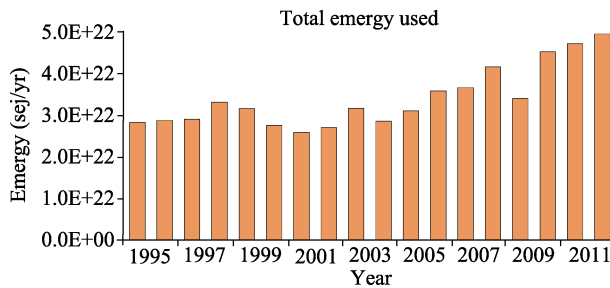

Figure 5 Total emergy used in the Mongolia’s economy during 1995–2012

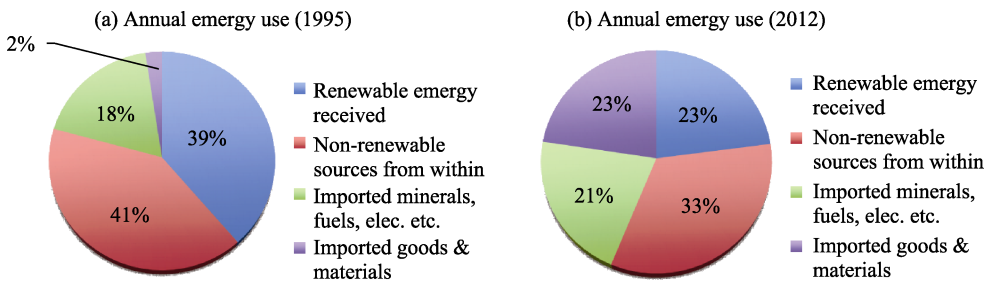

Figure 6 The change in energy sources in Mongolia in 1995 and 2012

3.3.2 Renewable resources and non-renewable resources derived within Mongolia

Renewable resources (R) of Mongolia were an important energy input, fluctuating between 8.46×10^{21} sej yr⁻¹ and 1.49×10^{22} sej yr⁻¹ (Figure 7) during 1995 and 2012. The fluctuations are due to changes in precipitation during the study period.

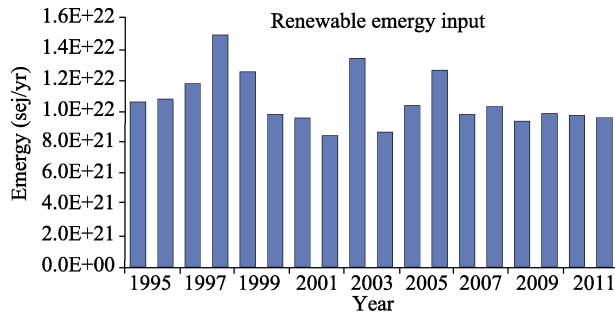

Figure 7 Renewable energy input to the Mongolia’s economy during 1995–2012

Figure 8 is a graph showing the time series of local non-renewable resources derived from within Mongolia including “dispersed rural sources” (N₀: primarily soil loss), “concentrated use” (N₁: fossil fuels and minerals) and “mineral and fossil fuels directly exported” (N₂). The total energy of these local non-renewables increased from 1.1×10^{22} sej to 1.40×10^{22} sej, over the study period, resulting in a 38% increase (see Appendix B). While the energy in soil loss due to erosion decreased about 30% from 3.3×10^{21} sej yr⁻¹ to 2.2×10^{21} sej yr⁻¹, the domestic use of fuels (mainly coal) and minerals increased nearly 50% from 7.9×10^{21} sej yr⁻¹ to 1.2×10^{22} sej yr⁻¹. The very large increase in fuel and mineral exports from 1.4×10^{21} sej yr⁻¹ in 1995 to 3.6×10^{22} sej yr⁻¹, representing a 25 fold increase, shows the extent of Mongolia’s involvement in providing resources to its trading partners.

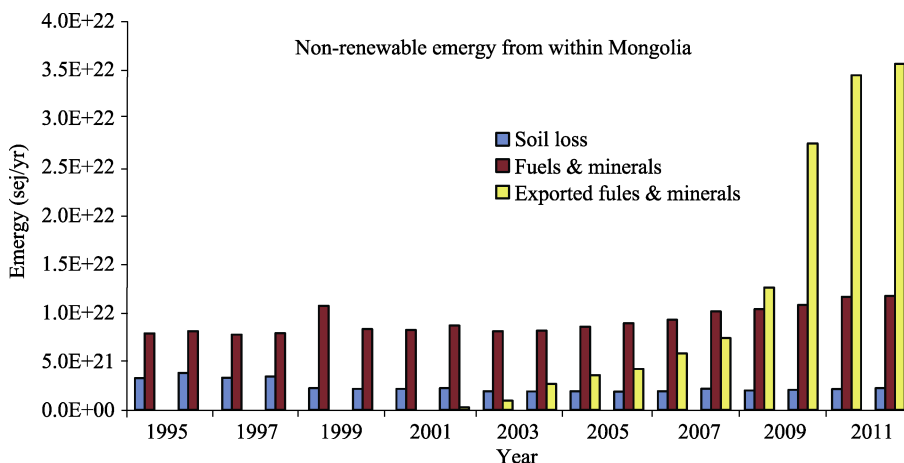

Figure 8 The total nonrenewable energy used and exported in Mongolia during 1995–2012

3.3.3 Imports and exports

Figure 9 shows Mongolia’s monetary balance of payments. In the years between 1995, 1996 and 1997 Mongolia had a positive balance of payments. Beginning in 1998 and continuing to 2012 (with the exception of 2006) balance of payments were increasingly negative.

The graphs in Figure 10 depict the energy of imports and exports including and not

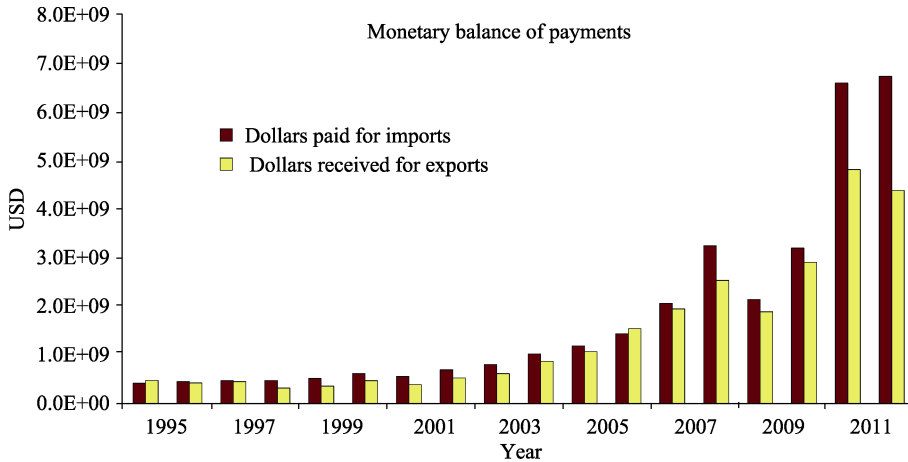

Figure 9 Mongolia's monetary balance of payments during 1995–2012

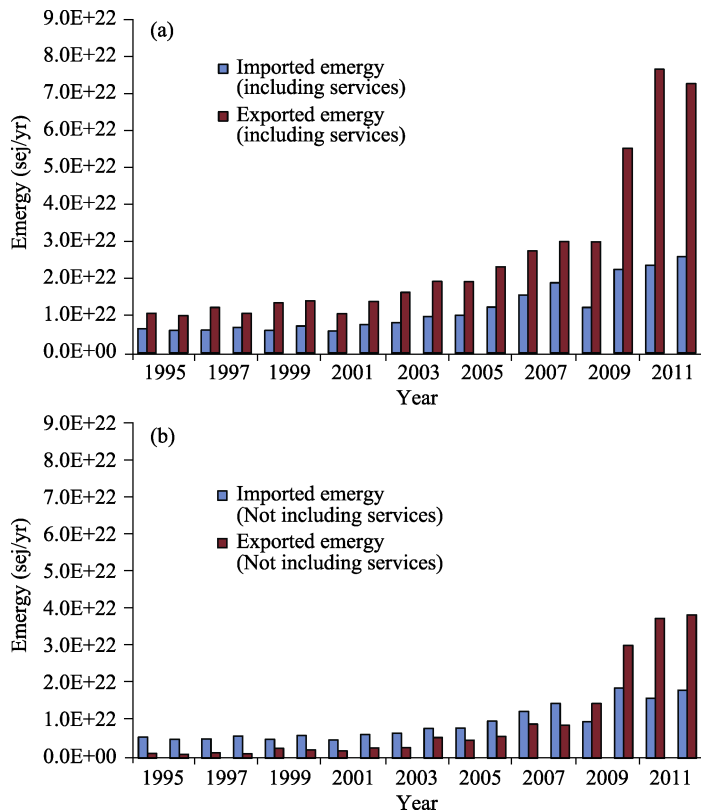

Figure 10 The energy of imports and exports of Mongolia during 1995–2012

(a. Energy of imports and exports including services; b. Energy of imports and exports NOT including services)

including services to show the relative contribution that services make to import and export energy. In Figure 10a services are included in both imports and exports. The services of exports were based on the energy dollar ratio of Mongolia, while the energy of services for imports was based on a world average energy dollar ratio. In Figure 10b, services are not included. When services are included the energy of Mongolia's exports outweighed the energy of imports in every year of the study (Figure 10a). In the late 1990s exported energy

exceeded imported energy by an average factor of 1.8 to 1 (i.e. on the average, exported energy was 1.8 times greater than imported energy). In the period 2010 to 2012 exported energy not only exceeded imported energy by an average of 2.8 to 1, but the magnitude of exported energy in 2012 was roughly 7 times the imported energy in 1995. When services are not included in export and import energy (Figure 10b), a different pattern emerges. The energy of imported goods, fuels and minerals exceeds exported energy from 1995 to 2008, however, after 2008 exported energy significantly increases, averaging about 2.3 times the energy in imports.

3.3.4 Energy intensities

Shown in Figure 11 are several energy intensities of Mongolia including energy use per person, aerial empower intensity and energy money ratio. Energy intensities were computed by dividing total energy use (U) by Mongolia’s population, area, and GDP respectively.

During the period 1995–2012, the population in Mongolia increased 24% from 2.32 million to 2.88 million, and the energy use per capita increased from 1.22×10^{16} sej/capita to 1.74×10^{16} sej/capita (Figure 10a), a 43% increase. World average energy use per capita during portions of this period was between 3×10^{16} and 5×10^{16} sej/capita (NEAD, 2016), suggesting that Mongolia is somewhat below world average.

Aerial empower intensity of Mongolia (Figure 10b) fluctuated between 1.6×10^{10} sej m⁻², and 2.1×10^{10} sej m⁻² until 2005 when significant increases in total energy use doubled aerial empower intensity in 2012 to 3.2×10^{10} sej m⁻². Compared to world averages during this same period of time, they were two orders of magnitude higher (NEAD, 2016: country average = 5.4×10^{12} sej m⁻² and median = 1.5×10^{12} sej m⁻²). Mongolia’s lower aerial empower intensity is characteristic of a country with a very modest level of development.

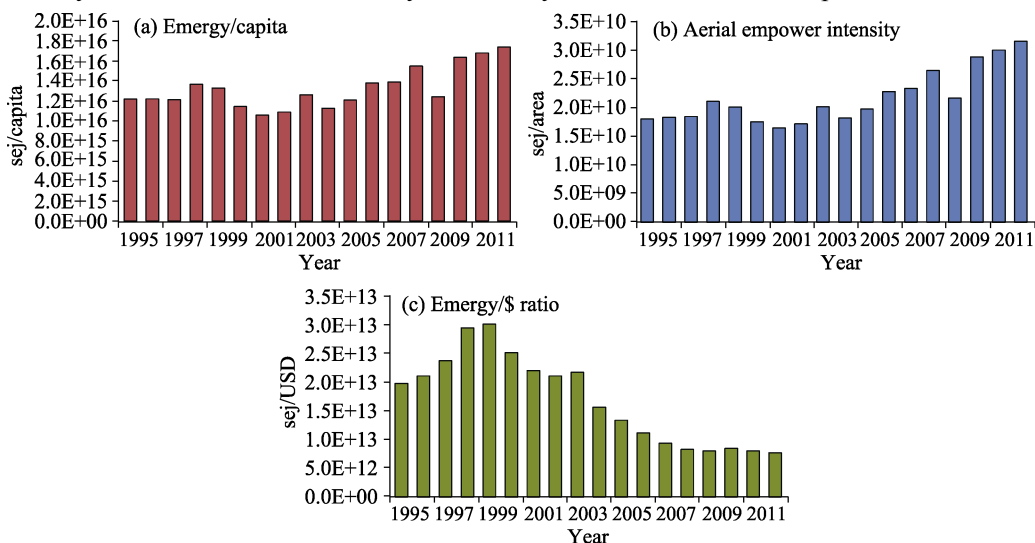

Figure 11 Energy intensity ratios of Mongolia during 1995–2012 (a. Energy per capita; b. Aerial empower intensity; c. Energy money ratio expressed in equivalent USDs)

Overall, the energy money ratio (EMR) of Mongolia (Figure 11c) during 1995–2012 decreased from 1.99×10^{13} sej/USD to 7.75×10^{12} sej/USD, a 61% decline. However, the ratio increased from 1995 to 1999 to over 3.0×10^{12} sej/USD, whereupon it declined almost every

year until 2012. The decline in the EMR indicates that the power of the Mongolian currency in purchasing real wealth is decreasing. In addition, the relatively high absolute values compared to the world average in 2008 (2.7×10^{12} sej/USD) indicates that Mongolia is consistently at a relatively high disadvantage when trading with other nations, exporting more resource wealth than in imports, dollar for dollar.

3.3.5 Emery indices of sustainability

We include three emery indices (Figure 12) that when considered together provide a relative measure of Mongolia's long-term sustainability. They include: 1) percentage of emery use that is locally renewable, 2) percentage of total use that is imported, and 3) percentage of total use that is exported.

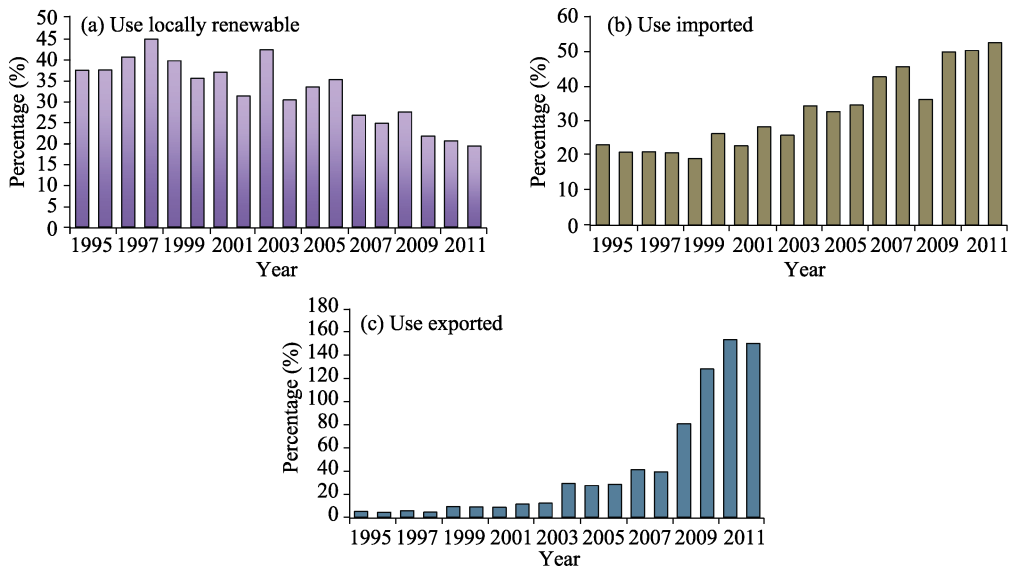

Figure 12 Emery indices of sustainability in Mongolia during 1995–2012 (a. Percentage of total use from local renewable sources; b. Percentage of total emery use that is imported; c. Percentage of total use that is exported)

Percentage of use locally renewable (%REN) – Mongolia had a relatively high percentage of total emery use that is locally renewable (Figure 12a). For the first 7 years of the study period, until 2001 the percentage of use that was locally renewable was between 35% and 45%, after 2001 the percentage began to decrease (with the exception of 2003 which had higher rainfall) to about 20% in 2012. By comparison, the global average for the countries in the NEAD (2016) database in the year 2008 was 10% (median value = 5%). This large percentage of renewable sources is primarily harnessed and integrated into Mongolia's economy through agriculture output.

Percentage of use imported (%IMP) – This index provides insight into the degree of dependency of an economy on external sources. In the early years of the study period, Mongolia's dependency on imports was about 20% (Figure 12b). Over the years the percentage of use that is imported has increased to the point that in 2012, Mongolia imported a little over 50% of total emery use. In 2008, the global average for countries in the NEAD (2016) was 55% (median value=56%) suggesting that Mongolia in recent years is more or less about average in terms of the percentage of use that is imported.

Percentage of use exported (%EXP) – This index relates exported emery to the total

energy used in the economy. It shows the degree to which Mongolia is depleting its non-renewable capital (Figure 12c). During the study period, the percentage of Mongolia's total energy use that was exported increased substantially from about 5% to over 150%. This suggests that in the last couple of years of the study period, Mongolia exported 1.5 times the energy than it consumed internally and if this energy could have been directed at productive processes within the country, significant increases in overall economic productivity could have been realized.

3.3.6 Energy performance indicators

Energy exchange ratio (EER) – The EER is measure of trade efficiency, is the ratio of energy received by the buyer, to the energy given, in a trade. Obviously, ratios greater than 1.0 indicate positive energy balance of payments, in which a country receives more energy than is embodied in its exports. During the study period Mongolia's EER was always less than 1.0 (Figure 13a). In 1995 Mongolia's EER was 0.7 and decreased steadily to 0.3 in 2012. In comparison with global averages Mongolia's EER was in a relatively low position in the available data, falling within the group of countries, i.e., Russia (0.26), China (0.43), Chile (0.44), Australia (0.29), Argentina (0.39), Brazil (0.4) and Saudi Arabia (0.14), which contributes large fluxes of real wealth to support growth in the global economies that receive them (NEAD, 2016).

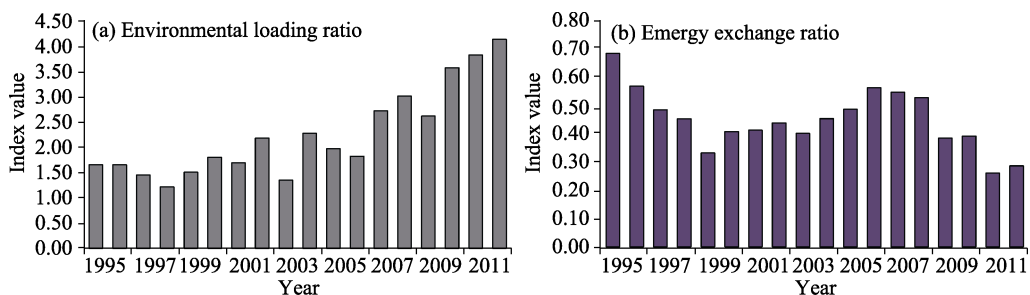

Figure 13 Energy performance indicators of Mongolia during 1995–2012

a. Environmental loading ratio, the ratio of non-renewable energy use to renewable energy use; b. Energy exchange ratio, the ratio of imported energy to exported energy

Environmental loading ratio (ELR) – The ELR is a ratio of non-renewable and imported energy use to renewable energy use (Odum 1996), it provides an indication of environmental pressures from the perspective of the renewable capacity of the environment to support economic processes and human endeavors. A large ELR indicates highly-intensive economic development and high environmental loads. In 2008, the average ELR for nations of the world was 102.4, while the median value is 17.3 (NEAD, 2016).

Because the environmental loading ratio (ELR) is composed of both non-renewable and renewable energy inputs to an economy, differences in either of the variables result in changes in the index. In general, we conclude that a low index results from either large renewable or relatively small non-renewable inputs. Since renewable flows are most generally spatial in their input, larger countries tend to have larger total renewable inputs and therefore the ratio can be lower by virtue of the fact that the renewable flows are larger. So two countries having the same non-renewable inputs but different area can have very different ELRs.

In light of the above, interpreting the ELR is not straightforward. Be that as it may, in

general, we believe that countries with ratios less than 10 have relatively low environmental load. This may be the result of a relatively small economy (Bolivia, Costa Rica, Guyana, Suriname, Uruguay, or Zambia) or because of a large surface area that is not intensely developed (Argentina, Australia, Brazil, Canada, Russia). Further, we believe that countries that have ELRs greater than 10 but less than 100 have moderate environmental load ... again tempered by either large area (Chile, Denmark, Norway, United States) or moderate sized economies (Botswana, Belize, Portugal, Venezuela). Finally, countries with ELRs greater than 100 tend to be relatively small in surface area and intensely developed (Austria, Finland, Italy, Israel, Germany).

The ELR of Mongolia (Figure 13b) remains relatively low having increased from 1.66 in 1995 to 4.15 in 2012. This would suggest that the overall pressure on Mongolia's environment is low. However, obviously this is an average over the entire country. There maybe, and surely are, numerous areas within Mongolia (urban centers, mining districts, etc) where there are considerable environmental pressures. Mongolia's relatively large land area (compared to population and developed areas) could be equated with a high capacity to absorb wastes, recycle by-products and provide other environmental services that are of fundamental importance to a sustainable development pattern.

4 Conclusions and suggestions

4.1 A word of caution

The findings in this national analysis cannot be compared to national analyses done for other countries in the past by multiplying these results by a simple ratio of the two baselines, for two reasons. First, the UEVs for minerals are significantly different from those used in the past, which also translates into very different UEVs for the metals like steel, aluminum and copper, etc. Second, we have used a UEV for rainfall that is almost 50% lower than the UEV used by Odum (1996) and that is given in the Center for Environmental Policy, Folio 1 (Odum, 2000). The UEV used in the present study was taken from a publication by Brown and Ulgiati (2016). Since rain and the emergy of geopotential (which is computed from rain) are the most important renewable energy inputs to Mongolia, the fact that their UEVs are about 50% lower makes simple comparison with other national analyses problematic. Add this difference to the different UEV's for minerals and metals and a simple ratio of baselines is obviously not appropriate.

4.2 Structure of Mongolia's economy

The structure of Mongolia's economy changed significantly during the 18-year period of this study. While total emergy use (U) in Mongolia increased 75% from 1995 to 2012 (Figure 5) its emergy per capita remains one of the lowest in the world (Figure 11). The percentage of renewable decreased from 39% in 1995 to 23% in 2012 while imported goods and materials increased from just 2% of total use to 23% (Figure 6). Imported fuels, minerals and electricity increased slightly from 18% to 21% of total emergy use. During this same period exports increased from 1.1×10^{22} sej yr⁻¹ to 7.3×10^{22} sej yr⁻¹, over a six fold increase in 18 years (Figure 8). By 2012, exports were about 150% of total emergy use in the economy (Figure 12). All in all, the growing dependence on imports and the dramatic increase in exports sug-

gests that Mongolia's economy is increasingly vulnerable to downturns in the world economy.

In the early years of this study, Mongolia had relatively large emery money ratios, increasing each year until reaching a maximum of 3.0×10^{13} sej/\$ then decreasing to about 7.8×10^{12} sej/\$ in 2012 (Figure 11). Since the world average EMR is much lower, and especially developed economies which are significantly lower, Mongolia is at a trade disadvantage with its currency, providing more emery per transaction to trading partners than it receives. This is highlighted in the annual emery exchange ratio of Mongolia (Figure 13a) showing consistent and increasing trade disadvantage over all years of this study. This can be interpreted as suggesting that far more resource wealth is exported from Mongolia than is received in imports. In essence, Mongolia is supporting its trading partner's economies at the expense of its own economy.

4.3 Value added by emery accounting

Standard economic national accounting treats the flows of resources as monetary flows. Since monetary flows are counter current to resource flows, i.e., they flow in the opposite direction from resource flows, emery accounting provides an important perspective on the picture of a nation's balance of trade. In monetary terms, if a country exports more than it imports (i.e. the monetary value of exports is greater than the money paid for imports), it is said that the economy has a trade surplus, a positive, or "favorable" balance of trade. Conversely, if the cost of a country's imports is greater than the money received for its exports, it is said to be functioning with a trade deficit, a negative or "unfavorable" balance of trade.

On the other hand, from an emery perspective, the opposite is true. If a country exports more emery than it imports, its emery trade balance is negative. And, of course, if it imports more emery than it exports, its emery trade balance is positive.

Often developed economies function with negative trade balance of payments monetarily, but have a positive emery balance. Under these circumstances, since resources are the true driver of the economy, the net result can be a positive influence on the economy. For instance, the USA has had a negative monetary balance of payments every year since 1976, in both "good times" and "bad" (TradingEconomics, 2017) while maintaining an average annual growth rate of 3.2% (TradingEconomics, 2017).

Developing economies, because they often export raw resources and import finished products, frequently have a negative balance of trade in both monetary and emery terms (Brown, 2003; Brown *et al.*; 2009). This can be a twofold blow to the economy. First a negative monetary balance of trade is generally financed through borrowing and thus the economy is more unsustainable in the long run and burdened with high interest rates. Second, the negative emery trade balance means that resource capital stocks are being drawn down and instead of driving the local economy and building infrastructure, resources are driving their trading partner's economy.

This is the case for Mongolia. For the majority of the 18 years included in this study its monetary and emery trade balances were negative (Figures 9 and 10), especially in 2010, 2011, and 2012. All in all, this twofold weakness becomes a major impediment to a healthy economy. Resources are not building "value" and driving economic productivity, and the money received from their sale is not sufficient to purchase needed imports, which generates a continuing downward economic spiral.

The obvious solution is to stop exports, or raise the price of exports. However, neither of these options is feasible. Thus a different strategy is necessary, one that recognizes the value of resources as economic drivers. Optimally the best strategy would be one where companies that sign agreements to develop Mongolia's mineral resources, provide the country with the means of developing the resources themselves and eventually developing the industrial capability to turn mineral resources into finished products. In this way the mineral wealth drives the economy to a far greater extent than the goods that can be purchased with the export income.

Clearly, it is important to adjust the resource utilization structure of Mongolia's economy. As long as Mongolia exports its raw resources and imports finished goods and materials (in 2012, exported energy was one and a half times the energy budget of the country), its energetic economy will continue to suffer from a negative energy trade balance, and the well-being of the population as measured by energy per capita will remain low. Keeping resources within the economy and using them to make products for export will provide jobs, and a major boost to the economy.

Often, developing countries caught in the downward economic spiral induced by double trade deficits, devalue their currency in the hopes of turning things around. The "economic rationale" for currency devaluation is primarily to combat trade imbalances by boosting exports (since devaluation in relation to other currencies causes exports to become less expensive) and reducing imports (since imports are more expensive). A second reason is that devaluation reduces the cost of interest payments on outstanding government debts. However from an energy perspective, devaluation only exacerbates the problems by increasing the export of valuable resources and lowering the quantity of imported energy, which ultimately slows the economy. Devaluing the Mongolian currency should be avoided at all costs, since a devalued currency makes resources less expensive in relation to other currencies and increases exports supporting other nations rather than supporting the Mongolia's economy.

Mongolia's renewable energy base is relatively low in comparison with other nations that have moderate climates, abundant rain, and coastal locations. What it lacks in renewable energy it more than makes up for with non-renewable fuels (coal) and mineral wealth. Like many developing economies with rich natural capital reserves, however, Mongolia is selling its wealth and using the income to purchase more and more finished products. Unfortunately, such a monetary policy may seem sound in the short run, but it is not sound energetic policy in the long run. Resources should be turned into economic infrastructure (buildings, roads, industrial capacity, etc.) within Mongolia, instead of in the countries with whom Mongolia trades. With economic infrastructure, Mongolia can begin to capitalize on its mineral and fuel wealth to develop a functioning economy. Without it, the country will remain poor, energetically, with one of the lowest per capita energy use in the world.

The energy perspective values resources not on their market value (referred to as "exchange value" by classical economists), but instead on their "use value". In agreement with many of the classical economists, energy is a measure of the "real wealth" of resources. In contrast, current economic thinking values resources on their exchange value, the result of which is a serious under valuation. Raw resources bring the lowest exchange values while finished products the highest. Developing countries like Mongolia which have relatively rich mineral resources cannot possibly get ahead trading high energy minerals for low energy

finished products. In every trade they lose emery...their high emery resources drive their trading partner's economy where they are turned into finished products and sold back to them. The emery perspective suggests policies that recognize this inherent inequity and a method to compute balanced trade between nations that would go a long way in alleviating the downward economic spiral and replace it with self-regenerating circle of economic progress.

Acknowledgements

We thank Luping Zhu and Lei Jin for their analytical work during the early stage of this project. We also thank Profs. Maochao Yan, Jiquan Chen, Lin Zhen for their helpful comments on an earlier version of this manuscript.

Additional information

Supplementary information accompanies this paper online.

References

- Adams T A, Barton P I, 2011. Combining coal gasification and natural gas reforming for efficient polygeneration. *Fuel Processing Technology*, 92(3): 639–655.
- Almeida C M V B, Barrella F A *et al.*, 2007. Emergetic ternary diagrams: Five examples for application in environmental accounting for decision-making. *Journal of Cleaner Production*, 15(1): 63–74.
- Bastianoni S B, Campbell D, Susani L *et al.*, 2005. The solar transformity of oil and petroleum natural gas. *Ecological Modelling*, 186(2): 212–220.
- Batjargal Z, 1997. Desertification in Mongolia. RALA Report No.200: 107–113.
- BGS, 2016. British Geological Survey. World Mineral Production. (Accessed August, 2016 at <http://www.bgs.ac.uk/mineralsuk/statistics/worldStatistics.html>)
- Brandt-Williams S L, 2001. Handbook of emery evaluation: A compendium of data for emery computation issued in a series of Folios. Folio# 4. Emery of Florida Agriculture. University of Florida, Gainesville, 40pp.
- Brown M T, 2003. Resource imperialism: Emery perspectives on sustainability, balancing the welfare of nations and international trade. In: Ulgiati S ed. *Advances in Energy Studies*. Proceeding of the conference held in Porto Venere, Italy, October 2002. University of Siena, Italy.
- Brown M T, Campbell D E, De Vilbiss C *et al.*, 2016. The geobiosphere emery baseline: A synthesis. *Ecological Modelling*, 339: 92–95.
- Brown M T, Cohen M J, Sweeney S, 2009. Predicting national sustainability: The convergence of energetic, economic and environmental realities. *Ecological Modelling*, 220(23): 3424–3438.
- Brown M T, Ulgiati S, 1997. Emery-based indices and ratios to evaluate sustainability: Monitoring economies and technology toward environmentally sound innovation. *Ecological Engineering*, 9(1/2): 51–69.
- Brown M T, Ulgiati S, 1999. Emery evaluation of the biosphere and natural capital. *Ambio*, 28(6): 486–493.
- Brown M T, Ulgiati S, 2011. Understanding the global economic crisis: A biophysical perspective. *Ecological Modelling* 223: 4–13.
- Brown M T, Ulgiati S, 2016. Emery accounting of global renewable sources. *Ecological Modelling*. doi: 10.1016/j.ecolmodel.2016.03.010.
- De Vilbiss C, Brown M T, 2015. New method to compute the emery of crustal minerals. *Ecological Modelling*. doi: 10.1016/j.ecolmodel.2015.04.007.
- De Vilbiss C, Brown M T, 2016. Emery research support for supply chains, Final Technical Report on Contract EP-11-C-000197. The Center for Environmental Policy, University of Florida, Gainesville, FL.
- CIA, 2016. The Central Intelligence Agency. The World Factbook 2013-14. Washington, DC: Central Intelligence Agency, 2013. Accessed August, 2016 at: <https://www.cia.gov/library/publications/the-world-factbook/index.html>.
- ECSP, 2017. In Mongolia, Climate Change and Mining Boom Threaten National Identity. NewSecurityBeat. Environmental Change and Security Program, Woodrow Wilson International Center for Scholars. Accessed March, 2017 at: <https://www.newsecuritybeat.org/2012/07/in-mongolia-climate-change-and-mining-boom>

- threaten-national-identity/.
- EIA, 2016. United States Energy Information Agency. International data portal. (accessed August 2016 at <http://www.eia.gov/beta/international/country.cfm?iso=MNG>).
- FAO Aquastat, 2016. Food and Agriculture Organization Aquastat database (accessed August, 2016 at <http://www.fao.org/nr/water/aquastat/main/index.stm>).
- FAOstat, 2016. Food and Agricultural Organization. Agricultural data portal. (accessed August 2016 at <http://faostat.fao.org/site/339/default.aspx>).
- IRENA, 2016. International Renewable Energy Agency, Global Atlas for Renewable Energy. (accessed August 2016 at <http://irena.masdar.ac.ae>).
- ISRIC, 2016. International Soil Reference and Information Centre, World Soil Information data portal. (Accessed August 2016 at <http://www.isric.org/content/data>).
- John R, Chen J, Lu N *et al.*, 2009. Land cover/land use change in semi-arid Inner Mongolia: 1992–2004. *Environmental Research Letters*, 4(4).
- MSY, 2009. Mongolian Statistical Yearbook. Ulaanbaatar, National Statistical Office of Mongolia.
- Mungunzul E, Chang T, 2016. Foreign Direct Investment in the Mongolian Mining Sector. *International Journal of u- and e-Service, Science and Technology*, 9(3): 249–258.
- NEAD, 2016. The National Environmental Accounting Database. Cneter for ENvironmental Policy, University of Florida (accessed August 2016 at <http://www.cep.ees.ufl.edu/nead/>).
- NREL, 2016. National Renewable Energy Laboratory. Wind energy resource atlas of Mongolia. (accessed August 2016 at <http://www.nrel.gov/wind/pdfs/28972.pdf>).
- Odum H T, 1996. Environmental Accounting: Emery and Environmental Decision Making. New York: John Wiley & Sons Inc.
- Odum H T, 2000. Handbook of Emery Evaluation. Folio#2. Emery of Global Processes. Florida, Center for Environmental Policy. University of Florida, Gainesville.
- Odum H T, Brown M T, Brandt-Williams S, 2000. Handbook of Emery Evaluation. Folio#2. Introduction and Global Budget. Florida, Center for Environmental Policy. University of Florida, Gainesville.
- OEC, 2016. AJG Simoes, CA Hidalgo. The Economic Complexity Observatory: An Analytical Tool for Understanding the Dynamics of Economic Development. Accessed August 2016 at <http://atlas.media.mit.edu/en/profile/country/mng/>.
- Palutikof J P, Davies T D, Kelly P M, 1984. A data bank of wind speed records for the British Isles and off-shore waters. In: Musgrove P ed. Wind Energy Conversion. Cambridge: Cambridge University Press, 414–425.
- Rótolo G C, Rydberg T, Lieblein G *et al.*, 2007. Emery evaluation of grazing cattle in Argentina's Pampas. *Agriculture, Ecosystems & Environment*, 119(3): 383–395.
- Tilley D R, 1999. Emery Basis of Forest Systems. PhD Dissertation, Department of Environmental Engineering Sciences, University of Florida.
- Tilley D R, Agostinho F, Campbell E *et al.*, 2012. The ISAER transformity database. International Society for Advancement of Emery Research. Available at www.emerydatabase.org.
- Trading Economics, 2017. United States Balance of Trade 1950–2017. Accessed February, 2017 at <http://www.tradingeconomics.com/united-states/balance-of-trade>.
- UN ComTrade, 2016. United Nations Stastics Division trade data portal (accessed August 2016 at <http://comtrade.un.org/data/>).
- UNEP, 2016. United Nations Environmental Program, DEWA/GRID-Geneva. Global Resource Information Database (Accessed August, 2016 at <http://www.grid.unep.ch/index.php?lang=en>).
- Vernooy R, 2011. How Mongolian Herders Are Transforming Nomadic Pastoralism. *The Solutions Journal*, 2(5): 82–87. Accessed August, 2016 at (<https://www.thesolutionsjournal.com/article/how-mongolian-herders-are-transforming-nomadic-pastoralism/>).
- Worden R L, Savada A M, 1989. Mongolia: A Country Study. Gov. Publishing Office, for the Library of Congress, Washington D.C.
- World Bank, 2016. World Bank Data portal-agricultural land. (accessed August, 2016 at <http://data.worldbank.org/indicator/AG.LND.AGRI.ZS?locations=MN>).
- WWO (WorldWeatherOnline). 2016. Accessed August 2016 at <https://www.worldweatheronline.com/ulaanbaatar-weather-averages/ulaanbaatar/mn.aspx>.
- Yang Z F, Jiang M M, Chen B *et al.*, 2010. Solar emery evaluation for Chinese economy. *Energy Policy*, 38(2): 875–886.
- MSY, 1995–2012. Mongolia Statistical Yearbook. (accessed October, 2016 at <http://www.1212.mn/>).
- Zhu L, Li H, Chen J *et al.*, 2012. Emery-based sustainability assessment of Inner Mongolia. *Journal of Geographical Sciences*, 22(5): 843–858.

Appendix A. Footnotes to Table 1

Renewable Sources			
1	Solar Radiation		
	Land area =	1.56E+12 m ²	(CIA, 2016)
	Insolation =	5.99E+05 J cm ⁻² y ⁻¹	(IRENA, 2016)
	Albedo =	30.00 (% of insolation)	Estimate
	Carnot efficiency =	0.93	
	Available energy (J) =	(Land area)*(avg sun)*(1-albedo)*(Carnot effic.) + (shelf area) (avg. sun)*Carnot effic.)	
		= (1.56 E+12 m ²) (1.09E6 J cm ⁻² y ⁻¹) (1.0E+04 cm ² m ⁻²) (0.70) (0.93)	
		= 6.10E+21 J y ⁻¹	
	UEV =	1.0	sej J ⁻¹
2	Earth Cycle		
	Land area =	1.56E+12 m ²	
	Heat flow =	1.26E+06 J m ⁻² y ⁻¹	(Internat. Heat Flow Database, 2010)
	Carnot efficiency =	9.50% = 1 - (287 K/ 317 K)	
	Available energy (J) =	(land area) (heat flow) (Carnot efficiency)	
		= (1.56 E+12 m ²) (2.0E6 J m ⁻² y ⁻¹) (0.095)	
		= 1.87E+17 J y ⁻¹	
	UEV =	4900	sej J ⁻¹ (Brown and Ulgiati, 2016)
3	Wind Energy		
	Land area =	1.56E+12 m ²	
	Shelf area =	0.00E+00 m ³	
	Density of air =	1.23E+00 kg m ⁻³	
	Geostrophic wind =	1.04E+01 m s ⁻¹	
	Land wind velocity =	5.76E+00 m s ⁻¹	(NERL, 2016)
	Land wind absorbed =	4.64E+00 m s ⁻¹	
	Land drag coeff. =	1.64E-03	(Palutikof <i>et al.</i> , 1984)
	Energy (J) =	(land area) (air density) (drag coefficient) (wind velocity absorbed ³) +	
		= (1.56 E+12 m ²) (1.23 kg m ⁻³) (1.64E-3) (4.64 m s ⁻³) (3.15 E7 s y ⁻¹)	
	Available energy (J) =	9.93E+18	J y ⁻¹
	UEV =	800	sej J ⁻¹ (Brown and Ulgiati, 2016)
4	Precipitation (chemical potential)		
	Land Area =	1.56E+12 m ²	
	Precipitation (land) =	0.17 m y ⁻¹	(FAO Aquastat, 2016)
	Transpiration rate =	93 %	Pot. Evapotranspiration (UNEP, 2016)
	Gibbs energy =	4720 J kg ⁻¹	

(To be continued on the next page)

(Continued)

Renewable Sources			
Available energy (J) =	(land area) (rainfall) (% transpired) (Gibbs energy of rain)		
=	$(1.56E+12 \text{ m}^2) (0.24 \text{ m y}^{-1}) (93\%) (1000 \text{ kg m}^{-3}) (4.72E+03 \text{ J kg}^{-1})$		
=	$1.13E+18 \text{ J y}^{-1}$		
UEV =	7000 sej J^{-1}		(Brown and Ulgiati, 2016)
5	Runoff Geopotential		
Land area =	$1.56E+12 \text{ m}^2$		
Runoff =	0.01 m y^{-1}	Precipitation – transpiration	
Average elevation =	1060 m		(NERL, 2016)
Available Energy (J) =	(runoff) (density) (area) (avg elevation difference) (gravity)		
=	$(0.16 \text{ m}) (1000 \text{ kg m}^{-3}) (1.56E12 \text{ m}^2) (750) (9.8 \text{ m s}^{-2})$		
=	$1.88E+17 \text{ J y}^{-1}$		
UEV =	12800 sej J^{-1}		(Brown and Ulgiati, 2016)
6	River Inflow (geopotential energy)		
Discharge =	$0.00E+00 \text{ m}^3 \text{ y}^{-1}$		(FAO Aquastat, 2016)
Elevation =	1060.00 m	(dif. inflow-outflow)	(NERL, 2016)
Water density =	$1000.00 \text{ kg m}^{-3}$		
Available energy (J) =	(discharge) (density) (Elevation difference) (gravity)		
=	$(0.00 \text{ m}^3) (1000 \text{ kg/m}^3) (1060 \text{ m}) (9.8 \text{ m s}^{-2})$		
=	$0.00E+00 \text{ J y}^{-1}$		
UEV =	12800 sej J^{-1}		(Brown and Ulgiati, 2016)
7	River Inflow (chemical energy)		
Discharge =	$0.00E+00 \text{ m}^3 \text{ y}^{-1}$		(FAO Aquastat, 2016)
TDS _{INFLOW} =	10 ppm		Rain TDS
TDS _{OUTFLOW} =	3500 ppm		estimate
Gas Constant	$8.134 \text{ J mol}^{-1} \text{ K}^{-1}$		
T =	287.25 K		
M weight water =	18.02 g		
Gibbs energy =	$((\text{gas constant}) \cdot (\text{T}) \cdot \ln(\text{TDS}_{\text{INFLOW}} / \text{TDS}_{\text{OUTFLOW}})) / (\text{M weight water})$		
=	$((8.13) \cdot (287.25) \cdot \ln(999990\text{ppm} / 999450\text{ppm})) / (18.01 \text{ g M}^{-1})$		
=	$4.53E-01 \text{ J g}^{-1}$		
Available energy (J) =	(discharge) $(1E6 \text{ g m}^{-3})$ (Gibbs energy)		
=	$0.00E+00$		
UEV =	21300 sej J^{-1}		(Brown and Ulgiati, 2016)
Indigenous Renewable Production			
8	Hydroelectricity		
Production =	$0.00E+00 \text{ kWh y}^{-1}$		(EIA, 2016)
Available Energy (J) =	$(\text{___ kWh y}^{-1}) \cdot (3.6 \text{ E6 J kWh}^{-1})$		
=	$0.00E+00 \text{ J y}^{-1}$		
UEV =	$2.54E+05 \text{ sej J}^{-1}$		(Odum, 1996)
9	Agricultural Production (grains, vegetables, etc):		
Production =	$7.87E+05 \text{ MT}$	(20% humidity)	(FAO, 2016)
Available energy (J) =	(Total production) (1 – water content) (energy content)		
=	$(\text{___ MT}) \cdot (1E06 \text{ g MT}^{-1}) \cdot (80\%) \cdot (4.0 \text{ kcal g}^{-1}) \cdot (4186 \text{ J kcal}^{-1})$		
=	$1.05E+16 \text{ J y}^{-1}$		
UEV =	$2.54E+05 \text{ sej J}^{-1}$		(Odum, 1996)

(To be continued on the next page)

(Continued)

Renewable Sources			
10	Livestock Production (meat)		
	Livestock production =	1.49E+05 MT (80% humidity)	(FAO, 2016)
	Available energy (J) =	(Total production) (1 – water content) (energy content)	
	=	(___ MT)*(1E+06 g MT ⁻¹)*(20%)*(5.0 kcal g ⁻¹)*(4186 J kcal ⁻¹)	
	=	6.24E+14 J y ⁻¹	
	UEV =	2.54E+06 sej J ⁻¹	(Odum, 1996)
11	Fishery Production		
	Fish catch =	1.85E+02 MT (80% humidity)	(FAO, 2016)
	Available energy (J) =	(Total production) (1 – water content) (energy content)	
	=	(___ MT)*(1E+06 g MT ⁻¹)*(5.0 kcal g ⁻¹)*(20%)*(4186 J kcal ⁻¹)	
	=	7.74E+11 J y ⁻¹	
	UEV =	2.54E+06 sej J ⁻¹	Odum, 1996)
12	Fuelwood Production		
	Fuelwood prod =	8.70E+05 m ³	(FAO, 2016)
	Available energy (J) =	(Total production) (1 – water content) (energy content)	
	=	(___ m ³) (0.5E6 g m ⁻³) (3.6 kcal g ⁻¹) (80%) (4186 J kcal ⁻¹)	
	=	5.24E+15 J y ⁻¹	
	UEV =	1.87E+04 sej J ⁻¹	(DeVilbiss & Brown, 2015)
13	Forest Extraction		
	Harvest =	2.53E+06 m ³	(FAO, 2016)
	Available energy (J) =	(Total production) (1 – water content) (energy content)	
	=	(___ m ³) (0.5E+06 g m ⁻³) (80%) (3.6 kcal g ⁻¹) (4186 J kcal ⁻¹)	
	=	1.53E+16 J y ⁻¹	
	UEV =	1.87E+04 sej J ⁻¹	(DeVilbiss & Brown, 2015)
Nonrenewable Resource Use from Within the Country			
14	Natural Gas		
	Consumption =	0.00E+00 m ³ y ⁻¹	(EIA, 2016)
	Available energy (J) =	(___ m ³ y ⁻¹) (energy content)	
	=	(___ m ³ y ⁻¹)*(8966 kcal m ⁻³)*(4186 J kcal ⁻¹)	
	=	0.00E+00 J y ⁻¹	
	UEV =	1.40E+05 sej J ⁻¹	(DeVilbiss & Brown, 2015)
15	Oil		
	Consumption =	1.87E+03 bbl y ⁻¹	(EIA, 2016)
	Available energy (J) =	(___ barrel/yr) (energy content)	
	=	(___ bbl y ⁻¹)*(5.86E9 J bbl ⁻¹)	
	=	1.10E+16 J y ⁻¹	
	UEV =	1.40E+05 sej J ⁻¹	(DeVilbiss & Brown, 2015)
16	Coal		
	Consumption =	5.92E+03 MT y ⁻¹	(EIA, 2016)
	Available energy (J) =	(___ MT y ⁻¹) (energy content)	
	=	(___ MT y ⁻¹)*(2.9E+10 J MT ⁻¹)	
	=	1.72E+17 J y ⁻¹	
	UEV =	5.21E+04 sej J ⁻¹	(DeVilbiss & Brown, 2015)
17	Minerals (including limestone and fertilizers)		(BGS, 2016)
	Consumption	UEV	(DeVilbiss & Brown, 2015)

(To be continued on the next page)

(Continued)

Renewable Sources				
Gypsum =	6.10E+04	MT y ⁻¹	5.26E+08	sej g ⁻¹
Phosphorus =	0.00E+00	MT y ⁻¹	2.34E+07	sej g ⁻¹
Potash =	0.00E+00	MT y ⁻¹	8.20E+09	sej g ⁻¹
Nitrogen =	0.00E+00	MT y ⁻¹	4.32E+10	sej g ⁻¹
Total consumption =	6.10E+04	MT y ⁻¹	5.26E+08	sej g ⁻¹
Mass (g) =	(___ E6 MT y ⁻¹)*(1E6 g MT ⁻¹)			
=	6.10E+10	g y ⁻¹		
UEV (weighed) =	5.26E+08	sej g ⁻¹		
18 Metals (mined – Al, Au, Cu, Fe, others)			(BGS, 2016)	
	Consumption		UEV	(DeVilbiss & Brown, 2015)
Aluminum (bauxite) =	3.71E+04	MT y ⁻¹	1.70E+07	sej g ⁻¹
Iron =	6.65E+05	MT y ⁻¹	2.27E+07	sej g ⁻¹
Copper =	3.76E+05	MT y ⁻¹	3.00E+08	sej g ⁻¹
Fluorspar =	6.89E+05	MT y ⁻¹	3.05E+07	sej g ⁻¹
Gold =	1.75E+01	MT y ⁻¹	5.00E+08	sej g ⁻¹
Silver =	2.05E+01	MT y ⁻¹	3.84E+08	
Zinc =	7.70E+04	MT y ⁻¹	1.50E+08	sej/g
Total Consumption =	1.84E+06	MT y ⁻¹	7.60E+07	sej/g
Mass (g) =	(___ E5 MT y ⁻¹)*(1E6 g MT ⁻¹)			
=	1.84E+12	g y ⁻¹		
UEV (weighed) =	7.60E+07	sej g ⁻¹		
19 TOPSOIL (soil organic matter)				
Harvested cropland =	1.16E+12	m ²	(World Bank, 2016)	
Soil loss =	1.22E+02	g m ⁻² y ⁻¹	(ISRIC, 2016)	
Avg. organic content (%) =	3	%		
Available energy (J) =	(___ m ² y ⁻¹)*(___ m ²)*(% organic)*(5.4 kcal g ⁻¹) (4186 J kcal ⁻¹)			
=	9.62E+16	J y ⁻¹		
UEV =	2.01E+04	sej J ⁻¹	(DeVilbiss & Brown, 2015)	
20 Water Extraction				
Extraction =	1.18E+09	m ³ y ⁻¹	(FAO Aquastat, 2016)	
Available energy (J) =	(___ m ³ y ⁻¹) (1.0E6 g m ⁻³) (Gibbs energy in water)			
=	(4.43E+8 m ³ y ⁻¹) (1.0 E6 g m ⁻³) (4.72 J g ⁻¹)			
=	5.58E+15	J y ⁻¹		
UEV =	4.80E+04	sej J ⁻¹	(DeVilbiss & Brown, 2015)	
Imports of Energy, Materials & Goods				
21 Fuels				
Natural gas =	5.00E+04	m ³ y ⁻¹	(EIA, 2016)	
Available energy (J) =	(___ m ³ y ⁻¹)*(8966 kcal m ⁻³)*(4186 J kcal ⁻¹)			
Oil derived fuels =	8.59E+08	l y ⁻¹	(EIA, 2016)	
Available energy (J) =	(___ l y ⁻¹)*(1.14E4 kcal l ⁻¹)*(4186 J kcal ⁻¹)			
Coal =	1.00E+03	MT y ⁻¹	(EIA, 2016)	
Available energy (J) =	(_ MT y ⁻¹)*(2.9E10 J MT ⁻¹)			
	Import amount		UEV	(DeVilbiss & Brown, 2015)
Natural gas =	1.88E+12	J y ⁻¹	1.40E+05	sej J ⁻¹
Oil derived fuels =	4.10E+16	J y ⁻¹	1.32E+05	sej J ⁻¹

(To be continued on the next page)

(Continued)

Renewable Sources				
Coal =	2.90E+13	J y ⁻¹	6.70E+04	sej J ⁻¹
Total fuels =	4.10E+16	J y ⁻¹	1.32E+05	
UEV (weighted)=	1.32E+05	sej J ⁻¹		
22 Metals				(UN TradeCom, 2016)
	Import amount		UEV	(DeVilbiss & Brown, 2015)
Aluminum ore (Bauxite) =	5.00E+04	MT y ⁻¹	1.70E+07	sej g ⁻¹
Aluminum =	2.40E+04	MT y ⁻¹	1.70E+08	sej g ⁻¹
Iron ore =	8.69E+01	MT y ⁻¹	2.27E+07	sej g ⁻¹
Steel =	0.00E+00	MT y ⁻¹	4.13E+09	sej g ⁻¹
Copper =	0.00E+00	MT y ⁻¹	2.82E+08	sej g ⁻¹
Gold =	0.00E+00	MT y ⁻¹	4.55E+11	sej g ⁻¹
Others =	1.77E+02	MT y ⁻¹	3.92E+08	sej g ⁻¹
Total imports =	7.43E+04	MT y ⁻¹	6.73E+07	sej g ⁻¹
Mass (g) =	(___ MT y ⁻¹)*(1E6 g MT ⁻¹)			
	7.43E+10	g y ⁻¹		
UEV (weighed) =	6.73E+07	sej g ⁻¹		
23 Minerals				(UN TradeCom, 2016)
	Import amount		UEV	(DeVilbiss & Brown, 2015)
Limestone =	3.73E+03	MT y ⁻¹	5.26E+08	sej g ⁻¹
Sand =	8.66E+05	MT y ⁻¹	1.56E+06	sej g ⁻¹
Gravel =	4.27E+05	MT y ⁻¹	1.03E+06	sej g ⁻¹
Phosphorus =	1.14E+02	MT y ⁻¹	2.34E+07	sej g ⁻¹
Potash =	8.36E+02	MT y ⁻¹	8.20E+06	sej g ⁻¹
Clay =	7.51E+06	MT y ⁻¹	4.50E+06	sej g ⁻¹
Others =	8.18E+06	MT y ⁻¹	9.41E+07	sej g ⁻¹
Total imports =	1.70E+07	MT y ⁻¹	4.75E+07	sej g ⁻¹
Mass (g) =	(___ MT y ⁻¹)*(1E6 g MT ⁻¹)			
	= 1.70E+13	g y ⁻¹		
UEV (weighed) =	4.75E+07	sej g ⁻¹		
24 Electricity				
Kilowatt Hrs/yr =	2.41E+08	kWh y ⁻¹		(EIA, 2016)
Available energy (J) =	(Energy production) (energy content)			
	= (___ kWh y ⁻¹)*(3.6 E6 J kWh ⁻¹)			
	8.68E+14	J y ⁻¹		
UEV =	2.54E+05	sej J ⁻¹		(Odum, 1996)
25 Food and Agricultural Products				
Imports =	4.92E+05	MT y ⁻¹		(UN TradeCom, 2016)
Available energy (J) =	(___ MT y ⁻¹)*(1E6 g MT ⁻¹)*(3.5 kcal g ⁻¹)*(4186 J kcal ⁻¹)*(80%)			
	5.77E+15	J y ⁻¹		
UEV =	4.28E+05	sej J ⁻¹		(Odum, 1996)
26 Livestock, Fish, Meat				
Imports =	1.94E+04	MT y ⁻¹		(UN TradeCom, 2016)
Available energy (J) =	(___ MT y ⁻¹)*(1E6 g MT ⁻¹)*(5 kcal g ⁻¹)*(4186 J kcal ⁻¹)*(0.22 protein)			
	8.93E+13	J y ⁻¹		
UEV =	2.54E+06	sej J ⁻¹	sej J ⁻¹	(Odum, 1996)

(To be continued on the next page)

(Continued)

Renewable Sources				
27	Plastics & Rubber			
	Imports =	1.64E+04	MT y ⁻¹	(UN TradeCom, 2016)
	Available energy (J) =	(___MT y ⁻¹)*(1000 kg MT ⁻¹)*(30.0E6 J kg ⁻¹)		
		= 4.92E+14	J y ⁻¹	
	UEV =	1.32E+05	sej J ⁻¹	(DeVilbiss & Brown, 2015)
28	Chemicals			
	Imports =	7.53E+04	MT y ⁻¹	(UN TradeCom, 2016)
	Mass (g) =	(___MT y ⁻¹)*(1E6 g MT ⁻¹)		
		= 7.53E+10	g y ⁻¹	
	UEV =	1.12E+10	sej g ⁻¹	*as pesticides
29	Finished Products (lumber, paper, textiles, glass, others)			(UN TradeCom, 2016)
		Import amount	UEV	(DeVilbiss & Brown, 2015)
	Lumber =	1.29E+05	MT y ⁻¹	2.70E+08 sej g ⁻¹
	Paper =	1.31E+04	MT y ⁻¹	8.46E+09 sej g ⁻¹
	Textiles =	1.16E+04	MT y ⁻¹	3.69E+09 sej g ⁻¹
	Steel =	2.63E+04	MT y ⁻¹	4.19E+09 sej g ⁻¹
	Others =	7.34E+05	MT y ⁻¹	4.15E+09 sej g ⁻¹
	Total imports =	9.14E+05	MT y ⁻¹	3.66E+09 sej g ⁻¹
	Energy (J) =	(___MT y ⁻¹)*(1E6 g MT ⁻¹)		
		= 9.14E+11	g y ⁻¹	
	UEV =	3.66E+09	sej g ⁻¹	
30	Machinery & Transportation Equipment			
	Imports =	7.52E+04	MT y ⁻¹	(UN TradeCom, 2016)
	Mass (g) =	(___E4 MT y ⁻¹)*(1E6 g MT ⁻¹)		
		= 7.52E+10	g y ⁻¹	
	UEV =	1.90E+10	sej g ⁻¹	(Rotolo <i>et al.</i> , 2007)
31	Services in Imports			
	Dollar value =	3.24E+09	\$US	(UN TradeCom, 2016)
	World energy/\$ ratio =	1.27E+12	sej \$ ⁻¹	
Exports of Energy, Materials and Goods				
32	Food and Agricultural Products			
	Exports =	2.11E+04	MT y ⁻¹	(UN TradeCom, 2016)
	Available energy (J) =	(___MT y ⁻¹)*(1E+06 g MT ⁻¹)*(80%)*(3.5 kcal g ⁻¹)*(4186 J kcal ⁻¹)		
		= 2.47E+14	J y ⁻¹	
	UEV =	2.54E+05	sej J ⁻¹	(Odum, 1996)
33	Livestock, Fish, Meat			
	Exports =	7.94E+04	MT y ⁻¹	(UN TradeCom, 2016)
	Available energy (J) =	(___MT y ⁻¹)*(1E+06 g MT ⁻¹)*(5 kcal g ⁻¹)*(4187 J kcal ⁻¹)*(22 prot)		
		= 3.66E+14	J y ⁻¹	
	UEV =	2.54E+06	sej J ⁻¹	(Odum, 1996)
34	Finished Products (lumber, paper, textiles, glass, others)			(UN TradeCom, 2016)
		Exported amount	UEV	
	Lumber =	1.23E+04	MT y ⁻¹	2.70E+08 sej g ⁻¹
	Paper =	3.66E+03	MT y ⁻¹	8.46E+09 sej g ⁻¹
	Textiles =	2.40E+04	MT y ⁻¹	3.69E+09 sej g ⁻¹

(To be continued on the next page)

(Continued)

Renewable Sources				
Others =	7.86E+04	MT y ⁻¹	4.15E+09	sej g ⁻¹
Total exports =	1.19E+05	MT y ⁻¹	3.79E+09	sej g ⁻¹
Available energy (J) =	$(\text{---MT y}^{-1})(1.0\text{E}+06 \text{ g MT}^{-1})$			
=	1.19E+11	g y ⁻¹		
UEV (weighed) =	3.79E+09	sej g ⁻¹		Odum, 1996
35 Fuels				
Natural gas =	0.00E+00	m ³ y ⁻¹		(EIA, 2016)
Available energy (J) =	$(\text{---m}^3 \text{ y}^{-1})(8966 \text{ kcal m}^{-3})(4186 \text{ J kcal}^{-1})$			
Oil derived fuels =	1.31E+08	l y ⁻¹		(EIA, 2016)
Available energy (J) =	$(\text{---l y}^{-1})(1.14\text{E}4 \text{ kcal l}^{-1})(4186 \text{ J kcal}^{-1})$			
Coal =	4.17E+06	MT y ⁻¹		(EIA, 2016)
Available energy (J) =	$(\text{---Quantity})(\text{J/Quantity})$			
	Exported amount		UEV	(DeVilbiss & Brown, 2016)
Natural gas =	0.00E+00	J y ⁻¹	1.40E+05	sej J ⁻¹
Oil derived fuels =	6.23E+15	J y ⁻¹	1.32E+05	sej J ⁻¹
Coal =	1.21E+17	J y ⁻¹	5.21E+04	sej J ⁻¹
Total fuels =	1.27E+17	J y ⁻¹	5.60E+04	sej J ⁻¹
UEV (weighed) =	5.60E+04	sej J ⁻¹		
36 Metals				(UN TradeCom, 2016)
	Exported amount		UEV	(DeVilbiss & Brown, 2016)
Aluminum ore (Bauxite) =	3.60E+04	MT y ⁻¹	1.70E+07	sej g ⁻¹
Aluminum =	1.29E+02	MT y ⁻¹	1.70E+10	sej g ⁻¹
Iron ore =	2.40E+04	MT y ⁻¹	2.27E+07	sej g ⁻¹
Steel =	0.00E+00	MT y ⁻¹	4.13E+09	sej g ⁻¹
Copper =	6.32E+05	MT y ⁻¹	2.82E+08	sej g ⁻¹
Zinc =	1.32E+04	MT y ⁻¹	1.52E+08	sej g ⁻¹
Others =	7.66E+04	MT y ⁻¹	3.92E+08	sej g ⁻¹
Total exports =	7.82E+05	MT y ⁻¹	2.73E+08	sej g ⁻¹
Mass (g) =	$(\text{---MT y}^{-1})(1\text{E}6 \text{ g MT}^{-1})$			
=	7.82E+11	g y ⁻¹		
UEV (weighed) =	2.73E+08	sej g ⁻¹		
37 Minerals				(UN TradeCom, 2016)
	Exported amount		UEV	(DeVilbiss & Brown, 2015)
Limestone =	7.53E+03	MT y ⁻¹	5.26E+08	sej g ⁻¹
Fluospar =	4.03E+04	MT y ⁻¹	2.34E+07	sej g ⁻¹
Potash =	0.00E+00	MT y ⁻¹	8.20E+09	sej g ⁻¹
Nitrogen =	0.00E+00	MT y ⁻¹	4.32E+10	sej g ⁻¹
Others =	0.00E+00	MT y ⁻¹	1.30E+10	sej g ⁻¹
Total Exports =	4.78E+04	MT y ⁻¹	1.03E+08	sej g ⁻¹
Mass (g) =	$(\text{---MT y}^{-1})(1.0\text{E}+06 \text{ g MT}^{-1})$			
=	4.78E+10	g y ⁻¹		
UEV (weighed)=	1.03E+08	sej g ⁻¹		
38 Chemicals				
Exports =	4.12E+03	MT y ⁻¹		(UN TradeCom, 2016)
Mass (g) =	$(\text{---MT y}^{-1})(1\text{E}6 \text{ g MT}^{-1})$			

(To be continued on the next page)

(Continued)

Renewable Sources				
	=	4.12E+09	g y ⁻¹	
39	Electricity	UEV = 1.12E+10	sej g ⁻¹	(as pesticides) (Brandt-Williams, 2000)
	Production exported/yr =	1.01E+07	kWh y ⁻¹	(UN TradeCom, 2016)
	Available energy (J) =	(Energy production) (energy content)		
	=	(____ kWh y ⁻¹)*(3.6 E6 J kWh ⁻¹)		
	=	3.64E+13	J y ⁻¹	
	UEV =	2.54E+05	sej J ⁻¹	(Odum, 1996)
40	Machinery & Transportation Equipment			
	Exports =	1.47E+03	MT y ⁻¹	(UN TradeCom, 2016)
	Mass (g) =	(____ MT y ⁻¹)*(1E6 g MT ⁻¹)		
	=	1.47E+09	g y ⁻¹	
	UEV =	1.44E+10	sej g ⁻¹	(Rotolo <i>et al.</i> , 2007)
41	Plastics and Rubber Products			
	Exports =	8.00E+00	MT y ⁻¹	(UN TradeCom, 2016)
	Available energy (J) =	(____ MT y ⁻¹)*(1000 kg MT ⁻¹)*(30.0E6 J kg ⁻¹)		
	=	2.40E+11		
	UEV =	1.32E+05	sej J ⁻¹ (as oil)	(DeVilbiss & Brown, 2015)
42	Services in Exports			
	Dollar value =	2.53E+09	\$US	(UN TradeCom, 2016)
	EMR =	8.52E+12	sej \$ ⁻¹	Computed

Appendix B. Summary of annual flows for Mongolia 1995-2012

Variable	Energy flow	1995	1996	1997	1998	1999	2000	2001
R	Renewable energy received	1.1E+22	1.1E+22	1.2E+22	1.5E+22	1.3E+22	9.8E+21	9.6E+21
N	Nonrenewable sources from within	1.1E+22	1.2E+22	1.1E+22	1.1E+22	1.3E+22	1.0E+22	1.0E+22
N ₀	Dispersed rural source	3.3E+21	3.8E+21	3.3E+21	3.4E+21	2.3E+21	2.2E+21	2.2E+21
N ₁	Concentrated use (fuels, etc.)	7.9E+21	8.1E+21	7.7E+21	7.9E+21	1.1E+22	8.3E+21	8.2E+21
N ₂	Minerals, fuels exported without use	1.4E+20	1.5E+20	1.5E+20	1.5E+20	1.5E+20	1.5E+20	1.6E+20
F ₁	Imported minerals, fuels, elec. etc.	5.0E+21	4.7E+21	4.9E+21	5.0E+21	3.2E+21	3.5E+21	3.5E+21
G ₁	Imported goods & materials	6.7E+20	4.3E+20	3.9E+20	9.6E+20	1.9E+21	2.7E+21	1.4E+21
P ₂ I	Imported services, total	8.1E+20	8.7E+20	8.8E+20	8.9E+20	9.5E+20	1.1E+21	9.8E+20
I	Dollars paid for all imports	4.2E+08	4.5E+08	4.7E+08	4.7E+08	5.1E+08	6.1E+08	5.5E+08
G _E	Exported products (goods & elec.)	1.1E+21	9.3E+20	1.3E+21	1.1E+21	2.5E+21	2.1E+21	1.9E+21
F _E	Exported fuels, minerals & electricity	1.4E+20	1.5E+20	1.9E+20	2.0E+20	2.1E+20	1.8E+20	1.8E+20
P ₁ E	Exported services, total	9.4E+21	9.0E+21	1.1E+22	9.4E+21	1.1E+22	1.2E+22	8.5E+21
E	Dollars paid for all exports	4.7E+08	4.2E+08	4.5E+08	3.2E+08	3.6E+08	4.7E+08	3.9E+08
GDP	Gross domestic product	1.4E+09	1.4E+09	1.2E+09	1.1E+09	1.0E+09	1.1E+09	1.2E+09
P ₁	Mongolia emery/\$ ratio	2.0E+13	2.1E+13	2.4E+13	3.0E+13	3.0E+13	2.5E+13	2.2E+13

Appendix C. Energy Indices overview of Mongolia

Name of Index	Expression	1995	1996	1997	1998	1999	2000
Indigenous non-renewable	N_0+N_1	1.11E+22	1.19E+22	1.11E+22	1.13E+22	1.30E+22	1.05E+22
Imported energy (including services)	$F+G_1+P_2I$	6.52E+21	6.03E+21	6.12E+21	6.89E+21	6.04E+21	7.25E+21
Imported energy (Not including services)	$F+G_1$	5.70E+21	5.16E+21	5.24E+21	6.01E+21	5.09E+21	6.15E+21
Total energy inflows (including services)	$R+F+G_1+P_2I$	1.71E+22	1.68E+22	1.79E+22	2.18E+22	1.86E+22	1.71E+22
Total energy inflows (Not including services)	$R+F+G_1$	1.63E+22	1.60E+22	1.70E+22	2.09E+22	1.77E+22	1.60E+22
Total energy used (including services)	$U=R+N_0+N_1+F+G_1+P_2I$	2.83E+22	2.88E+22	2.90E+22	3.31E+22	3.16E+22	2.76E+22
Total energy used (Not including services)	$U=R+N_0+N_1+F+G_1$	2.75E+22	2.79E+22	2.81E+22	3.23E+22	3.06E+22	2.65E+22
Exported energy (including services)	$G_E+P_1E+N_2$	1.07E+22	1.01E+22	1.22E+22	1.06E+22	1.35E+22	1.41E+22
Exported energy (Not including services)	N_2+G_E	1.29E+21	1.08E+21	1.46E+21	1.25E+21	2.68E+21	2.27E+21
Emergy yield	$Y=R+N+F+G_1+P_2I$	2.83E+22	2.88E+22	2.90E+22	3.31E+22	3.16E+22	2.76E+22
Percent energy used from home sources	$(N_0+N_1+R)/U$	0.77	0.79	0.79	0.79	0.81	0.74
Imports – Exports (\$)	$I - E$	-5.80E+07	2.66E+07	1.68E+07	1.56E+08	1.55E+08	1.48E+08
Imports – Exports (sej)	$(F+G_1+P_2I)-(G_E+P_1E+N_2)$	-4.18E+21	-4.04E+21	-6.13E+21	-3.75E+21	-7.50E+21	-6.82E+21
Ratio of export to imports	$(G_E+P_1E+N_2)/(F+G_1+P_2I)$	1.64	1.67	2.00	1.54	2.24	1.94
Ratio of export to imports (Not including services)	$G_E+N_2/(F+G_1)$	0.23	0.21	0.28	0.21	0.53	0.37
Percent use, locally renewable	R/U	38%	38%	41%	45%	40%	36%
Percent of use purchased import (Emergy dependency)	$(F+G_1+P_2I)/U$	23%	21%	21%	21%	19%	26%
Percent of use that is free	$(R+N_0+N_1)/U$	49%	51%	52%	55%	47%	44%
Percent of total use that is exported	$(N_2+G_E+F_E)/U$	5%	4%	6%	4%	9%	9%
Ratio of concentrated to rural	$(F_1+G_1+N_1+P_{21})/(R+N_0)$	1.04	0.96	0.92	0.80	1.13	1.30
Environmental loading ratio (ELR)	$(N_0+N_1+F+G_1+P_2I)/(R)$	1.66	1.66	1.46	1.22	1.51	1.81
Emergy investment ratio (EIR)	$(F_1+G_1+P_2I)/(R+N_0+N_1)$	0.30	0.27	0.27	0.26	0.24	0.36
Emergy exchange ratio (EER)	$(F+G_1+P_2I)/(N_2+G_E+P_1E)$	0.68	0.57	0.48	0.45	0.33	0.41
Aerial empower intensity	$U/Area$	1.81E+10	1.84E+10	1.85E+10	2.12E+10	2.02E+10	1.76E+10
Use per capita	$U/Population$	1.22E+16	1.22E+16	1.21E+16	1.37E+16	1.33E+16	1.14E+16
Emergy money ratio (EMR)	U/GDP	1.99E+13	2.12E+13	2.39E+13	2.96E+13	3.03E+13	2.53E+13

Appendix C. Energy Indices overview of Mongolia (continued)

Name of Index	Expression	2002	2003	2004	2005	2006	2007
Indigenous non-renewable	N_0+N_1	1.09E+22	1.01E+22	1.01E+22	1.05E+22	1.08E+22	1.12E+22
Imported emergy (including services)	$F+G_1+P_2I$	7.62E+21	8.16E+21	9.80E+21	1.01E+22	1.24E+22	1.56E+22
Imported emergy (Not including services)	$F+G_1$	6.40E+21	6.78E+21	8.07E+21	8.16E+21	1.01E+22	1.27E+22
Total emergy inflows (including services)	$R+F+G_1+P_2I$	1.61E+22	2.16E+22	1.85E+22	2.05E+22	2.50E+22	2.54E+22
Total emergy inflows (Not including services)	$R+F+G_1$	1.49E+22	2.02E+22	1.68E+22	1.86E+22	2.27E+22	2.25E+22
Total emergy used (including services)	$U=R+N_0+N_1+F+G_1+P_2I$	2.70E+22	3.17E+22	2.86E+22	3.10E+22	3.58E+22	3.66E+22
Total emergy used (Not including services)	$U=R+N_0+N_1+F+G_1$	2.58E+22	3.03E+22	2.69E+22	2.91E+22	3.35E+22	3.37E+22
Exported emergy (including services)	$G_E+P_1E+N_2$	1.39E+22	1.63E+22	1.93E+22	1.92E+22	2.32E+22	2.75E+22
Exported emergy (Not including services)	N_2+G_E	2.78E+21	2.88E+21	5.60E+21	4.90E+21	5.89E+21	9.21E+21
Emergy yield	$Y=R+N+F+G_1+P_2I$	2.70E+22	3.17E+22	2.86E+22	3.10E+22	3.58E+22	3.66E+22
Percent emergy used from home sources	$(N_0+N_1+R)/U$	0.72	0.74	0.66	0.67	0.66	0.57
Imports – Exports (\$) (sej)	$I - E$	1.67E+08	1.85E+08	1.51E+08	1.19E+08	-1.07E+08	1.14E+08
Imports – Exports (sej)	$(F+G_1+P_2I)-(G_E+P_1E+N_2)$	-6.27E+21	-8.18E+21	-9.49E+21	-9.11E+21	-1.09E+22	-1.19E+22
Ratio of export to imports	$(G_E+P_1E+N_2)/(F+G_1+P_2I)$	1.82	2.00	1.97	1.90	1.88	1.76
Ratio of export to imports (Not including services)	$G_E+N_2/(F+G_1)$	0.43	0.42	0.69	0.60	0.59	0.73
Percent use, locally renewable	R/U	31%	42%	30%	34%	35%	27%
Percent of use purchased import (Emergy dependency)	$(F+G_1+P_2I)/U$	28%	26%	34%	33%	34%	43%
Percent of use that is free	$(R+N_0+N_1)/U$	40%	49%	37%	40%	41%	32%
Percent of total use that is exported	$(N_2+G_E+F_E)/U$	11%	12%	29%	27%	28%	41%
Ratio of concentrated to rural	$(F_1+G_1+N_1+P_{21})/(R+N_0)$	1.52	1.06	1.69	1.51	1.46	2.12
Environmental loading ratio (ELR)	$(N_0+N_1+F+G_1+P_2I)/(R)$	2.19	1.36	2.28	1.98	1.83	2.73
Emergy investment ratio (EIR)	$(F_1+G_1+P_2I)/(R+N_0+N_1)$	0.39	0.35	0.52	0.48	0.53	0.74
Emergy exchange ratio (EER)	$(F+G_1+P_2I)/(N_2+G_E+P_1E)$	0.44	0.40	0.45	0.49	0.56	0.55
Aerial empower intensity	$U/Area$	1.73E+10	2.02E+10	1.83E+10	1.98E+10	2.29E+10	2.34E+10
Use per capita	$U/Population$	1.09E+16	1.26E+16	1.13E+16	1.21E+16	1.38E+16	1.39E+16
Emergy money ratio (EMR)	U/GDP	2.12E+13	2.19E+13	1.57E+13	1.34E+13	1.12E+13	9.42E+12

Appendix C. Emergy indices overview of Mongolia (continued)

Name of Index	Expression	2008	2009	2010	2011	2012
Indigenous non-renewable	N_0+N_1	1.23E+22	1.24E+22	1.29E+22	1.38E+22	1.40E+22
Imported emergy (including services)	$F+G_1+P_2I$	1.89E+22	1.23E+22	2.26E+22	2.37E+22	2.60E+22
Imported emergy (Not including services)	$F+G_1$	1.48E+22	9.87E+21	1.89E+22	1.62E+22	1.84E+22
Total emergy inflows (including services)	$R+F+G_1+P_2I$	2.93E+22	2.17E+22	3.24E+22	3.34E+22	3.56E+22
Total emergy inflows (Not including services)	$R+F+G_1$	2.52E+22	1.93E+22	2.88E+22	2.60E+22	2.80E+22
Total emergy used (including services)	$U=R+N_0+N_1+F+G_1+P_2I$	4.16E+22	3.40E+22	4.53E+22	4.72E+22	4.96E+22
Total emergy used (Not including services)	$U=R+N_0+N_1+F+G_1$	3.75E+22	3.16E+22	4.17E+22	3.97E+22	4.20E+22
Exported emergy (including services)	$G_E+P_1E+N_2$	3.00E+22	3.00E+22	5.53E+22	7.66E+22	7.27E+22
Exported emergy (Not including services)	N_2+G_E	8.90E+21	1.48E+22	3.05E+22	3.78E+22	3.87E+22
Emergy yield	$Y=R+N+F+G_1+P_2I$	4.16E+22	3.40E+22	4.53E+22	4.72E+22	4.96E+22
Percent emergy used from home sources	$(N_0+N_1+R)/U$	0.54	0.64	0.50	0.50	0.48
Imports – Exports (\$)	$I - E$	7.10E+08	2.52E+08	2.92E+08	1.78E+09	2.35E+09
Imports – Exports (sej)	$(F+G_1+P_2I)-(G_E+P_1E+N_2)$	-1.11E+22	-1.77E+22	-3.27E+22	-5.29E+22	-4.67E+22
Ratio of export to imports	$(G_E+P_1E+N_2)/(F+G_1+P_2I)$	1.59	2.44	2.45	3.24	2.80
Ratio of export to imports (Not including services)	$G_E+N_2)/(F+G_1)$	0.60	1.50	1.61	2.33	2.11
Percent use, locally renewable	R/U	25%	28%	22%	21%	19%
Percent of use purchased import (Emergy dependency)	$(F+G_1+P_2I)/U$	46%	36%	50%	50%	52%
Percent of use that is free	$(R+N_0+N_1)/U$	54%	33%	26%	25%	24%
Percent of total use that is exported	$(N_2+G_E+F_E)/U$	39%	81%	128%	153%	150%
Ratio of concentrated to rural	$(F_1+G_1+N_1+P_2I)/(R+N_0)$	2.32	1.99	2.79	2.96	3.18
Environmental loading ratio (ELR)	$(N_0+N_1+F+G_1+P_2I)/(R)$	3.02	2.63	3.59	3.84	4.15
Emergy investment ratio (EIR)	$(F_1+G_1+P_2I)/(R+N_0+N_1)$	0.83	0.57	0.99	1.01	1.10
Emergy exchange ratio (EER)	$(F+G_1+P_2I)/(N_2+G_E+P_1E)$	0.53	0.38	0.39	0.26	0.29
Aerial empower intensity	$U/Area$	2.66E+10	2.18E+10	2.90E+10	3.02E+10	3.17E+10
Use per capita	$U/Population$	1.55E+16	1.24E+16	1.64E+16	1.68E+16	1.74E+16
Emergy money ratio (EMR)	U/GDP	8.34E+12	8.08E+12	8.52E+12	8.05E+12	7.75E+12